

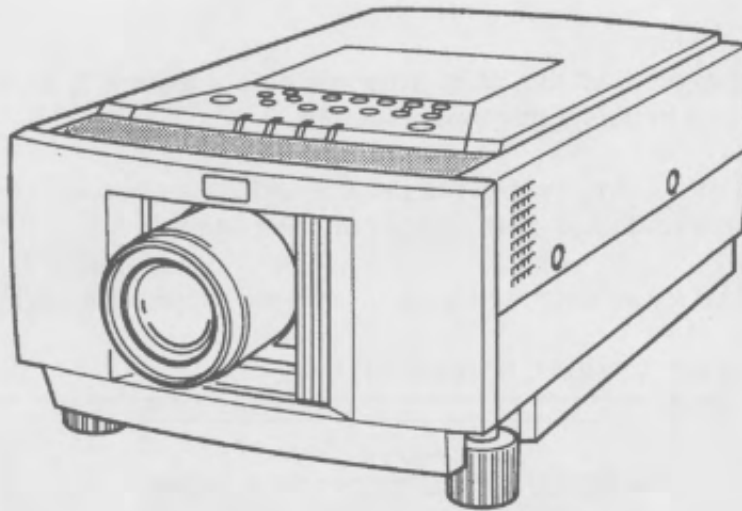

MULTIMEDIA PROJECTOR

# MODEL LC-XGA970U



## OWNER'S INSTRUCTION MANUAL

## INFORMATION TO THE USER

NOTE: This equipment has been tested and found to comply with the limits for a Class A digital device, pursuant to Part 15 of the FCC Rules. These limits are designed to provide reasonable protection against harmful interference when the equipment is operated in a commercial environment. This equipment generates, uses, and can radiate radio frequency energy and, if not installed and used in accordance with the instruction manual, may cause harmful interference to radio communications. Operation of this equipment in a residential area is likely to cause harmful interference in which case the user will be required to correct the interference at his own expense.

## SAFETY PRECAUTIONS

### WARNING:

**TO REDUCE THE RISK OF FIRE OR ELECTRIC SHOCK, DO NOT EXPOSE THIS APPLIANCE TO RAIN OR MOISTURE.**

The projector has a grounding-type AC line plug. This is a safety feature to be sure that the plug will fit into the power outlet. Do not try to defeat this safety feature.

Intense light source. Do not stare directly into the projection lens as possible eye damage could result. Be especially careful that children do not stare directly into the beam.

If the projector will not be used for an extended time, unplug the projector from the power outlet.

READ AND KEEP THIS OWNER'S MANUAL FOR LATER USE.

	<b>CAUTION</b> RISK OF ELECTRIC SHOCK DO NOT OPEN	
<b>CAUTION: TO REDUCE THE RISK OF ELECTRIC SHOCK, DO NOT REMOVE COVER (OR BACK). NO USER-SERVICEABLE PARTS INSIDE. REFER SERVICING TO QUALIFIED SERVICE PERSONNEL.</b>		
 THIS SYMBOL INDICATES THAT DANGEROUS VOLTAGE CONSTITUTING A RISK OF ELECTRIC SHOCK IS PRESENT WITHIN THIS UNIT.	 THIS SYMBOL INDICATES THAT THERE ARE IMPORTANT OPERATING AND MAINTENANCE INSTRUCTIONS IN THE OWNER'S MANUAL WITH THIS UNIT.	

### IMPORTANT:

For your protection in the event of theft or loss of this LC Data-Grade projector, please record the Model Number and Serial Number located on the rear of unit and retain this information. Refer to these numbers whenever you call upon your authorized dealer regarding this product.

**Do not discard shipping carton and packing materials. These items may be needed for storage or future servicing.**

Model No: LC-XGA970U

Serial No: \_\_\_\_\_

## IMPORTANT SAFETY INSTRUCTIONS

All the safety and operating instructions should be read before the product is operated.

Read all of the instructions given here and retain them for later use. Unplug this projector from AC power supply before cleaning. Do not use liquid or aerosol cleaners. Use a damp cloth for cleaning.

Do not use attachments not recommended by the manufacturer as they may cause hazards.

Do not place this projector on an unstable cart, stand, or table. The projector may fall, causing serious injury to a child or adult, and serious damage to the projector. Use only with a cart or stand recommended by the manufacturer, or sold with the projector. Wall or shelf mounting should follow the manufacturer's instructions, and should use a mounting kit approved by the manufacturer.

Do not expose this unit to rain or use near water... for example, in a wet basement, near a swimming pool, etc...

Slots and openings in the back and bottom of the cabinet are provided for ventilation, to insure reliable operation of the equipment and to protect it from overheating.

The openings should never be covered with cloth or other material, and the bottom opening should not be blocked by placing the projector on a bed, sofa, rug, or other similar surface. This projector should never be placed near or over a radiator or heat register.

This projector should not be placed in a built-in installation such as a bookcase unless proper ventilation is provided.

This projector should be operated only from the type of power source indicated on the marking label. If you are not sure of the type of power supplied, consult your authorized dealer or local power company.

Do not overload wall outlets and extension cords as this can result in fire or electric shock. Do not allow anything to rest on the power cord. Do not locate this projector where the cord may be damaged by persons walking on it.

Never push objects of any kind into this projector through cabinet slots as they may touch dangerous voltage points or short out parts that could result in a fire or electric shock. Never spill liquid of any kind on the projector.

Do not attempt to service this projector yourself as opening or removing covers may expose you to dangerous voltage or other hazards. Refer all servicing to qualified service personnel.

Unplug this projector from wall outlet and refer servicing to qualified service personnel under the following conditions:

- When the power cord or plug is damaged or frayed.
- If liquid has been spilled into the projector.
- If the projector has been exposed to rain or water.
- If the projector does not operate normally by following the operating instructions. Adjust only those controls that are covered by the operating instructions as improper adjustment of other controls may result in damage and will often require extensive work by a qualified technician to restore the projector to normal operation.
- If the projector has been dropped or the cabinet has been damaged.
- When the projector exhibits a distinct change in performance-this indicates a need for service.

When replacement parts are required, be sure the service technician has used replacement parts specified by the manufacturer that have the same characteristics as the original part. Unauthorized substitutions may result in fire, electric shock, or injury to persons.

Upon completion of any service or repairs to this projector, ask the service technician to perform routine safety checks to determine that the projector is in safe operating condition.



This projector is equipped with a grounding type AC line plug. Should you be unable to insert the plug into the outlet, contact your electrician. Do not defeat the safety purpose of this grounding type plug.

Follow all warnings and instructions marked on the projectors.

For added protection to the projector during a lightning storm, or when it is left unattended and unused for long periods of time, unplug it from the wall outlet. This will prevent damage due to lightning and powerline surges.



An appliance and cart combination should be moved with care. Quick stops, excessive force, and uneven surfaces may cause the appliance and cart combination to overturn.

# TABLE OF CONTENTS

	PAGE		PAGE
<b>INTRODUCTION</b>	5	SOUND MUTE FUNCTION	28
COMPATIBILITY	5	ZOOM ADJUSTMENT	28
IMAGE RESOLUTION	5	FOCUS ADJUSTMENT	28
PORTABILITY	5	NORMAL PICTURE FUNCTION	28
UNPACKING THE PROJECTOR	5	FREEZE PICTURE FUNCTION	28
TRADEMARKS	5	FINE SYNC ADJUSTMENT	28
<b>POWER REQUIREMENT</b>	6	MENU OPERATION	29-46
<b>DESCRIPTION</b>	7	MODE SELECT	29
<b>SETTING-UP THE PROJECTOR</b>	8-9	SOUND ADJUSTMENT	30
POSITIONING	8	LANGUAGE ADJUSTMENT	30
ROOM LIGHT	8	MENU EXIT	30
VENTILATION	8	COLOR SYSTEM SELECT	31
LEVELING AND ELEVATING ADJUSTMENTS	8	PICTURE IMAGE ADJUSTMENT	32
<b>MOVING THE PROJECTOR</b>	9	PICTURE SCREEN ADJUSTMENT	33
<b>CONNECTING THE PROJECTOR</b>	10-17	COMPUTER SYSTEM SELECT	34
CONNECTING THE COMPUTER	10-14	COMPATIBLE COMPUTER SPECIFICATION	35
Connecting an IBM-compatible desktop computer	11	PICTURE IMAGE ADJUSTMENT	36
Connecting a Macintosh desktop computer	12	PICTURE POSITION ADJUSTMENT	37
Connecting an IBM-compatible laptop computer	13	PC ADJUSTMENT	38-41
Connecting a Macintosh PowerBook computer	14	AUTO IMAGE FUNCTION	42
CONNECTING THE VIDEO EQUIPMENT	15-16	PICTURE SCREEN ADJUSTMENT	43
CONNECTING AN EXTERNAL SPEAKER	17	OTHER FUNCTION SETTING	44-46
<b>OPERATION OF CONTROLS</b>	18-20	AUTO RETRACT	44-45
TOP OF THE PROJECTOR	18-19	BLUE BACK	44-45
REAR OF THE PROJECTOR	20	DISPLAY	44-45
<b>OPERATION OF REMOTE CONTROL</b>	21-23	CEILING	44-45
REMOTE CONTROL BATTERY INSTALLATION	23	REAR	44-45
USING THE REMOTE CONTROL UNIT	23	LAMP AGE	46
<b>CONTROL THE PROJECTOR</b>	24-26	<b>AIR FILTER CARE AND CLEANING</b>	47
DIRECT OPERATION	24	<b>TEMPERATURE WARNING INDICATOR</b>	47
MENU OPERATION	25-26	<b>LAMP REPLACEMENT</b>	48
<b>USING THE PROJECTOR</b>	27-46	<b>CLEANING THE LENS</b>	49
TO TURN ON THE PROJECTOR	27	<b>TROUBLESHOOTING</b>	49-50
TO TURN OFF THE PROJECTOR	27	<b>TECHNICAL SPECIFICATIONS</b>	51
DIRECT OPERATION	28		
MODE SELECT	28		
SOUND VOLUME ADJUSTMENT	28		

# INTRODUCTION

The projector is a multimedia projector designed for portability, durability, and ease to use. The projector utilizes built-in multimedia features, a palette of 16.77 million colors, and active matrix liquid crystal display (LCD) technology.

## COMPATIBILITY

The projector is compatible with many different types of personal computers and video devices, including:

- IBM-compatible computers, including laptops, up to 1280 × 1024 resolution.
- Apple Macintosh and PowerBook computers up to 1280 × 1024 resolution.
- Various VCRs, video disc players, video cameras, satellite TV tuners or other AV equipment using any of the worldwide video standards, including NTSC, NTSC4.43, PAL and SECAM.

## IMAGE RESOLUTION

The resolution of the projector's projected image is 1024 × 768. The projector displays computer images just as they appear on your computer's monitor. Screen resolutions between 1024 × 768 and 1280 × 1024 are compressed to 1024 × 768. The projector cannot display screen resolutions above 1280 × 1024. If your computer's screen resolution is higher than 1280 × 1024, reset it to a lower resolution before you connect the projector.

## PORTABILITY

The projector is extremely compact in size and weight. Having a sophisticated shape like a brief case with a retractable carrying handle, the projector will help you make powerful presentations wherever you go. To strengthen the portability, the LENS RETRACT function is designed to protect the lens from being damaged during transportation. With this function, the lens is retracted and lens shutter door is shut when the power is off.

## UNPACKING THE PROJECTOR

The projector comes with the parts shown listed below. Check to make sure all are included. If any parts are missing, contact an authorized dealer or service station.

- Owner's Manual.
- Warranty Card.
- AC Power Cord.
- Remote Control Transmitter Unit and batteries.
- Protective Dust Cover.
- VGA Cable.
- VGA/MAC Adapter.
- Mouse Cable for PS/2 port.
- Mouse Cable for serial port.
- Mouse Cable for ADB port.

## TRADEMARKS

- Apple, Macintosh, and PowerBook are trademarks or registered trademarks of Apple Computer, Inc.
- IBM and PS/2 are trademarks or registered trademarks of International Business Machines, Inc.

## POWER REQUIREMENTS

Your projector uses nominal input voltages of 100-120 VAC. The projector automatically selects the correct input voltage. The projector is designed to work with single-phase power systems having a grounded neutral conductor. To reduce the risk of electrical shock, do not plug into any other type of power system. Consult your authorized dealer or service station if you are not sure what type of power is supplied to your building.

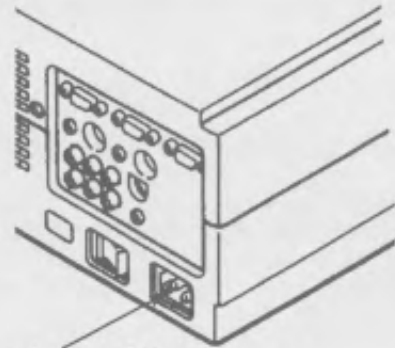

Connect the AC power supply cord (supplied) to the projector.

Projector side (Female)

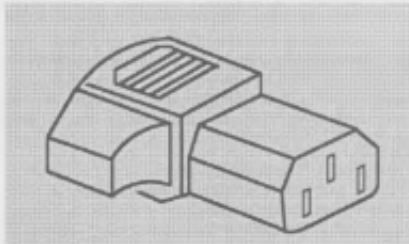

AC outlet side (Male)

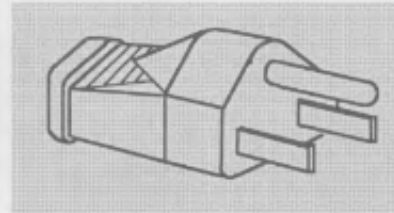

# DESCRIPTION

## FRONT

INFRARED  
REMOTE  
RECEIVER

PROJECTION  
LENS

LENS  
SHUTTER

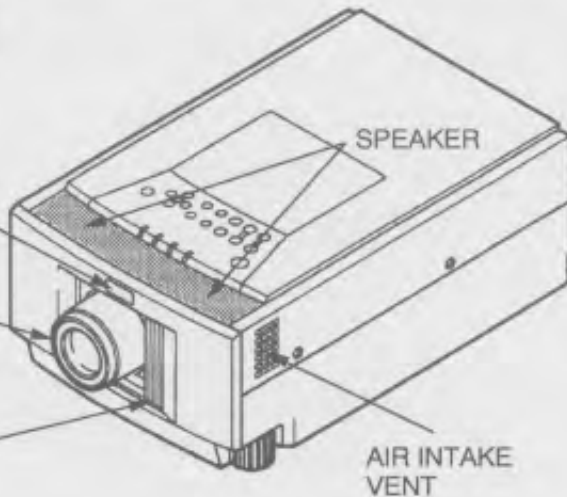

SPEAKER

AIR INTAKE  
VENT

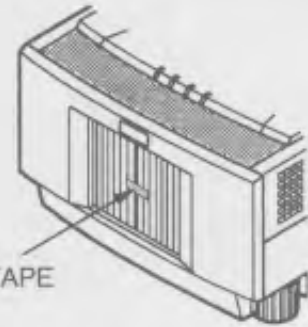

TAPE

NOTE: Please remove the tape before turn on the projector.

## REAR

EXHAUST VENT



### CAUTION HOT AIR !

Air blown from the exhaust vent is hot. Observe the following when handling your projector or choosing a location to install it.

- Keep heat-sensitive objects away from the exhaust port.
- If you set the projector on top of a metallic surface, the surface will become hot because of the hot air exhaust. Be careful when handling.
- Do not touch the cabinet near to the exhaust vent, and especially screws and metallic parts. These parts will become hot while the projector is used.

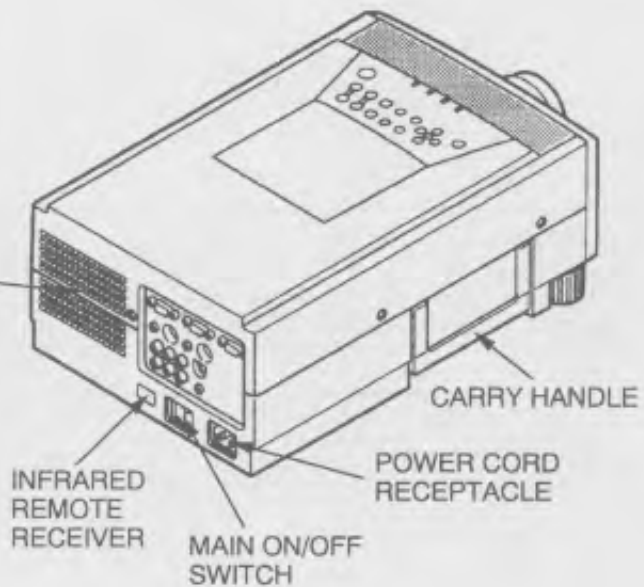

INFRARED  
REMOTE  
RECEIVER

MAIN ON/OFF  
SWITCH

POWER CORD  
RECEPTACLE

CARRY HANDLE

## BOTTOM

LAMP COVER

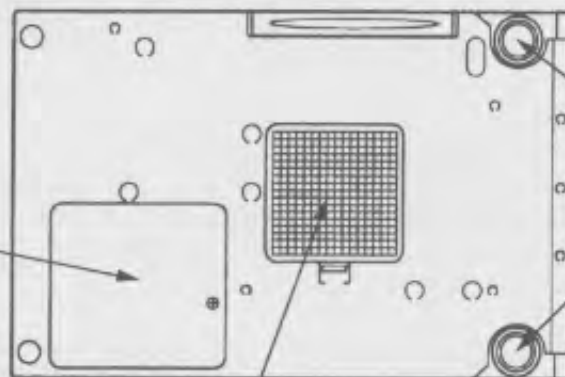

AIR INTAKE  
VENT

LEVELING/ELEVATING  
FEET

# SETTING-UP THE PROJECTOR

- POSITIONING:**
- This projector is basically designed to project on a flat projection surface.
  - This projector can be focused from 3.6' (1.1m) ~ 47' (14.3m).
  - Use the illustration below as an example when positioning the projector to the screen.

## ROOM LIGHT

Ideally the projector should be placed in a room with limited light. Picture quality will be directly affected by lighting conditions.

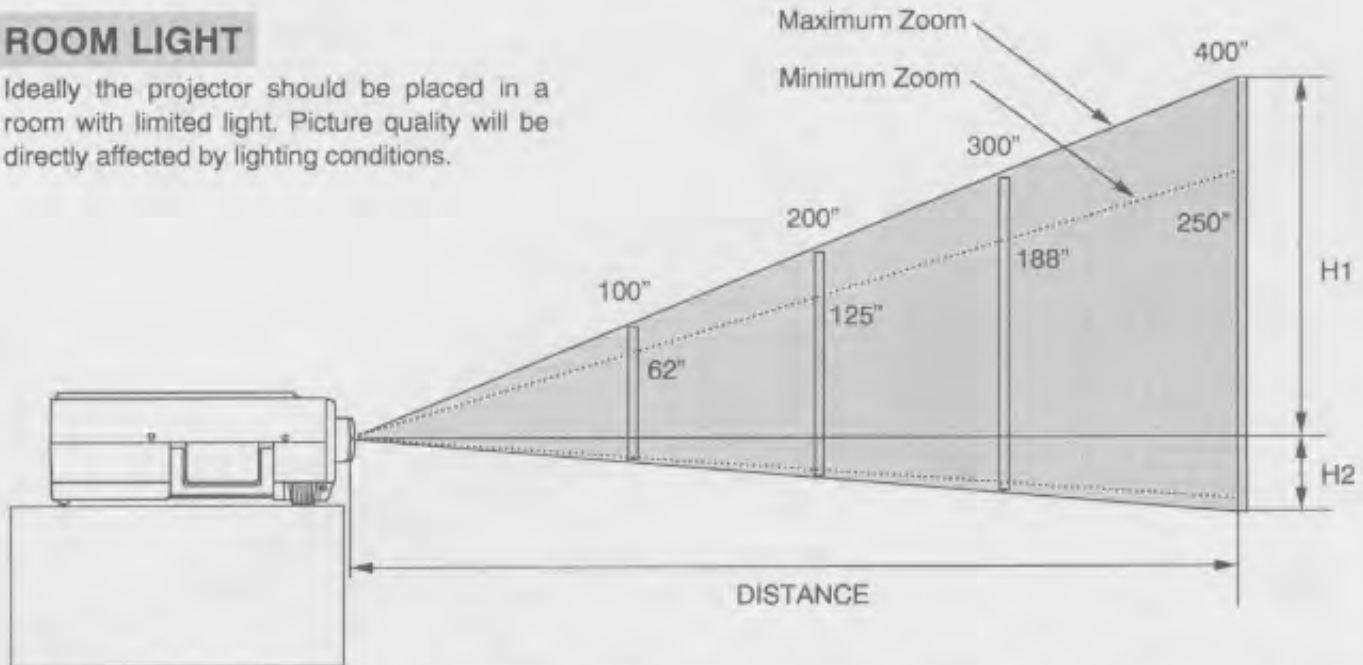

Screen Size	Max. Zoom	32"	60"	100"	150"	200"	300"	400"
	Min. Zoom	20"	37"	62"	94"	125"	188"	250"
Distance		3.6'(1.1 m)	6.9'(2.1 m)	11.8'(3.6 m)	17.8'(5.4 m)	23.7'(7.2 m)	35.2'(10.7 m)	47'(14.3 m)

Screen Size (W × H) inch	20"	60"	100"	150"	200"	300"	400"
	16 × 12	49 × 36	80 × 60	120 × 90	160 × 120	240 × 180	320 × 240
Height (H1)	10.7 inch	32 inch	53 inch	80 inch	106 inch	160 inch	212 inch
Height (H2)	1.3 inch	4 inch	7 inch	10 inch	14 inch	20 inch	28 inch

## VENTILATION

Although this projector has a cooling fan to protect from overheating, please be careful to set the projector so that it can cool properly and you can avoid a risk of fire and malfunction.



- Do not cover the vents with papers or other materials.
- Keep the rear grill at least 3.3' (1m) away from any object.
- Make sure that there are no objects under the projector. An object under the projector may prevent the projector from taking the cooling air through the bottom vent.

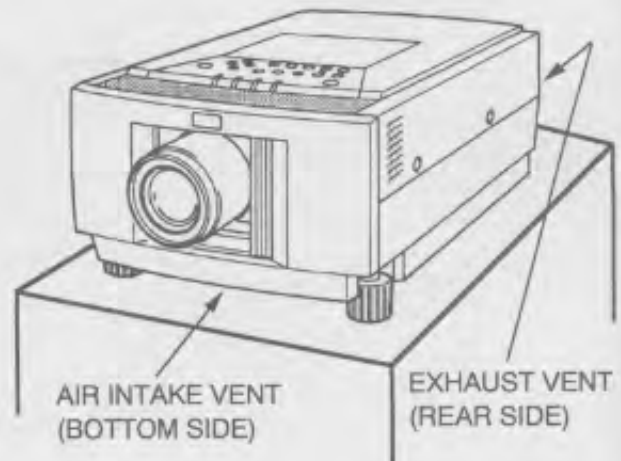



## LEVELING AND ELEVATING ADJUSTMENTS

Screen positioning adjustment can be made with the two leveling/elevating feet.

Adjustments of up to  $6.5^{\circ}$  are possible by rotating the feet on the bottom of the projector.

Level the projector, by rotating the two feet (left and right) on the bottom of the projector.

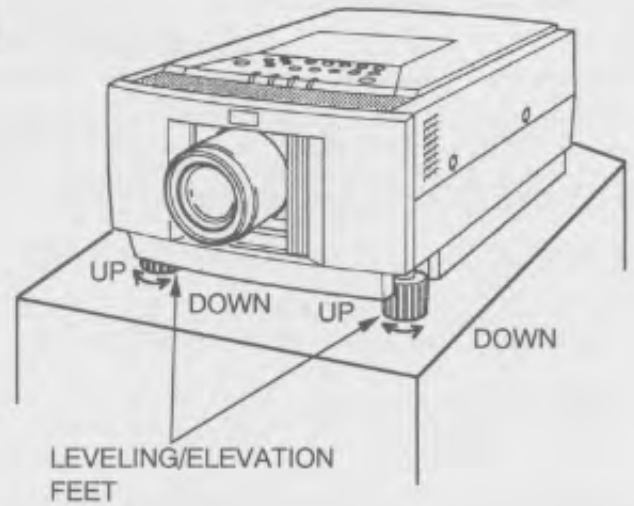

## MOVING THE PROJECTOR

Use the carry handle when moving the projector.

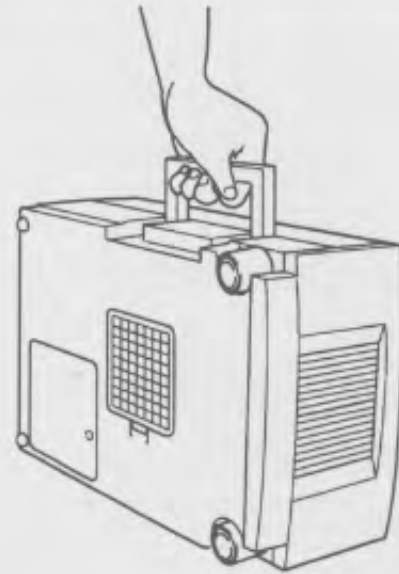

### CAUTION IN CARRYING OR TRANSPORTING THE PROJECTOR

- Do not drop or give a shock to the projector, otherwise damage or malfunction may result.
- When carrying the projector, use a Eiki recommended Carrying Case.
- Do not transport the projector by using a courier or transport service in an unsuitable transport case. This may cause damage to the projector. To transport the projector through a courier or transport service, use a Eiki recommended Case.
- For a carrying or transportation cases, contact a Eiki authorized dealer.

# CONNECTING THE PROJECTOR

Your projector is equipped with various audio/video inputs and outputs including Computer HDB15-pin (VGA) terminals, Monitor HDB15-pin (VGA) terminals and S-VHS video.

## CONNECTING THE COMPUTER

### CONNECTING TO THE COMPUTER INPUT HDB15-PIN (VGA) TERMINALS (1 and 2)

Personal computers can be connected to the HDB15-pin (VGA) terminal on the projector.

- Connect the computer to these terminals using the VGA cable or VGA cable with VGA/MAC adapter (provided).

**WARNING:** For projectors, the VGA cable provided is designed to reduce RFI (Radio Frequency Interference) emissions. For regulatory compliance reasons, this cable must be used and must not be replaced by any other cable.

### CONNECTING TO THE MONITOR OUTPUT HDB15-PIN (VGA) TERMINAL

This terminal contain the information that is viewed on the screen.

Monitor can be connected to the HDB15-pin (VGA) terminal on the projector.

- Connect the monitor to this terminal using the monitor cable (not provided).



#### Pin No./Signal

- 1 Red input
- 2 Green input
- 3 Blue input
- 4 Sense 2
- 5 Ground (Horiz. sync.)
- 6 Ground (Red)
- 7 Ground (Green)
- 8 Ground (Blue)

#### Pin No./Signal

- 9 Non Connect
- 10 Ground (Vert. sync.)
- 11 Sense 0
- 12 Sense 1
- 13 Horiz. sync.
- 14 Vert. sync.
- 15 Reserved

### CONNECTING TO THE COMPUTER AUDIO INPUT JACKS (1 and 2)

- Connect audio outputs from your computer to these jacks using the audio cable (not provided).

### CONNECTING TO THE MULTI-POLE 12-PIN (CONTROL PORT) CONNECTORS (1 and 2)

- When the computer is operated by the remote control unit, connect three different type of cables (provided) between control port and computer mouse port or serial port.

COMPUTER TYPE	CABLE
IBM Compatible computer with PS/2 mouse port.	Mouse Cable for PS/2 port.
IBM Compatible computer with serial control port.	Mouse Cable for Serial port.
Apple Macintosh computer with ADB mouse port.	Mouse Cable for ADB port.

#### ■ CONTROL PORT

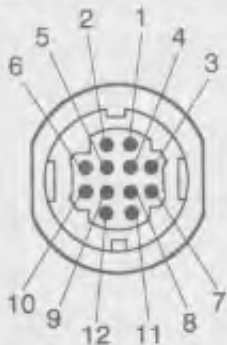

	PS/2 Port	Serial Port	ADB Port
1	————	TxD	————
2	CLK	————	ADB
3	DATA	————	————
4	————	————	————
5	————	※ RxD	————
6	————	————	————
7	————	READY	————
8	————	————	————
9	GND	GND	GND
10	————	————	————
11	————	————	————
12	————	————	————

#### CONTROL PORT CABLE REMOVAL HINT

To disconnect the control port cable connector proceed as follows.

1. Hold the portion (A) of the connector.
2. Pull the portion (B) to disconnect.

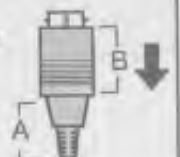

※ **NOTE:** The RxD port (5 pin on the Serial Port) is provided on control port 2 connector only. If you control the projector by computer, you must connect control port 2 connector.

## Connecting an IBM-compatible desktop computer

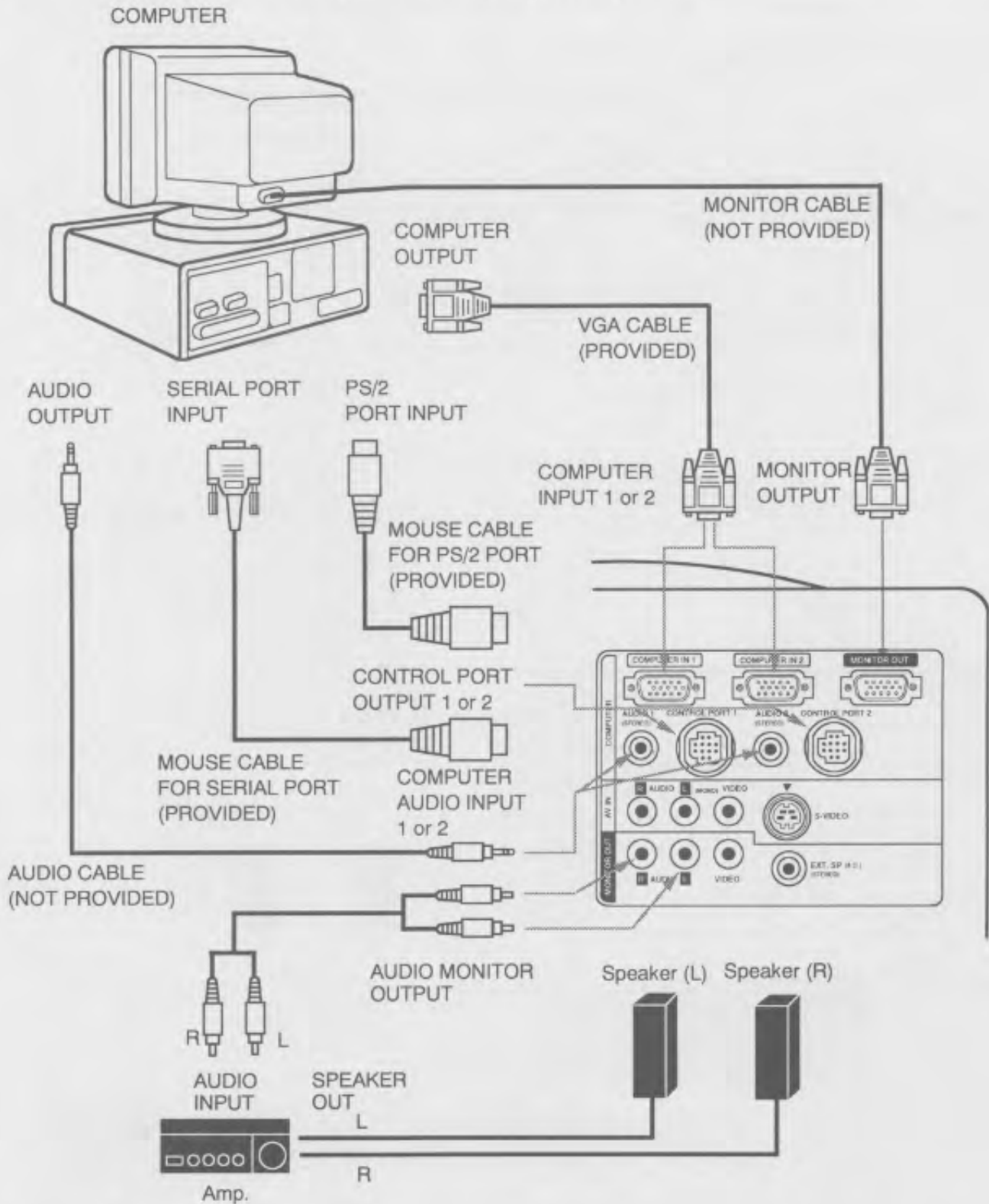

### **CAUTION**

The hook up should be done as per the above illustration. After hook up, turn on the projector, monitor, computer, in that order.

## Connecting a Macintosh desktop computer

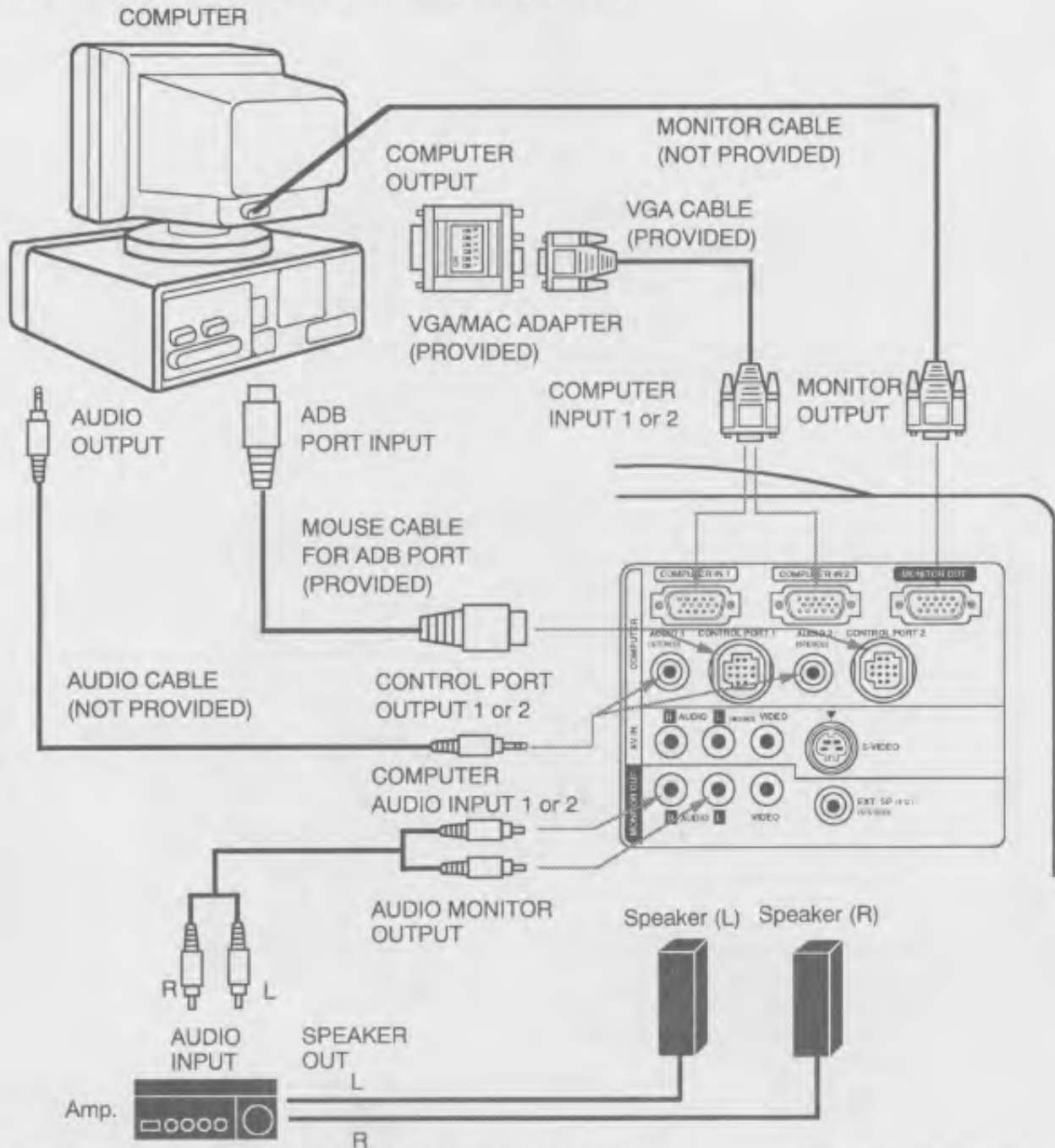

Set the slide switches as shown in the table below depending on the RESOLUTION MODE that you want to use before you turn on the projector and computer.

RESOLUTION MODE	SW1	SW2	SW3	SW4	SW5	SW6
13" MODE (640 × 480)	ON	OFF	OFF	OFF	OFF	OFF
16" MODE (832 × 624)	OFF	OFF	OFF	OFF	OFF	ON
19" MODE (1024 × 768)	OFF	OFF	OFF	ON	OFF	OFF
21" MODE (1152 × 870)	ON	ON	ON	OFF	OFF	OFF

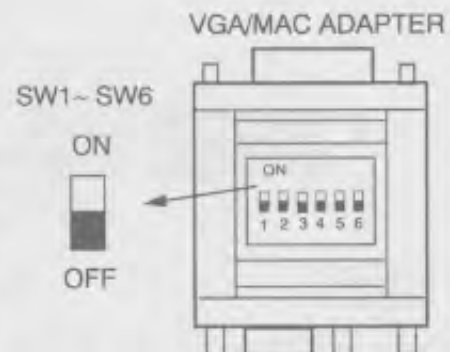

## CAUTION

The hook up should be done as per the above illustration. After hook up, turn on the projector, monitor, computer, in that order.

## Connecting an IBM-compatible laptop computer

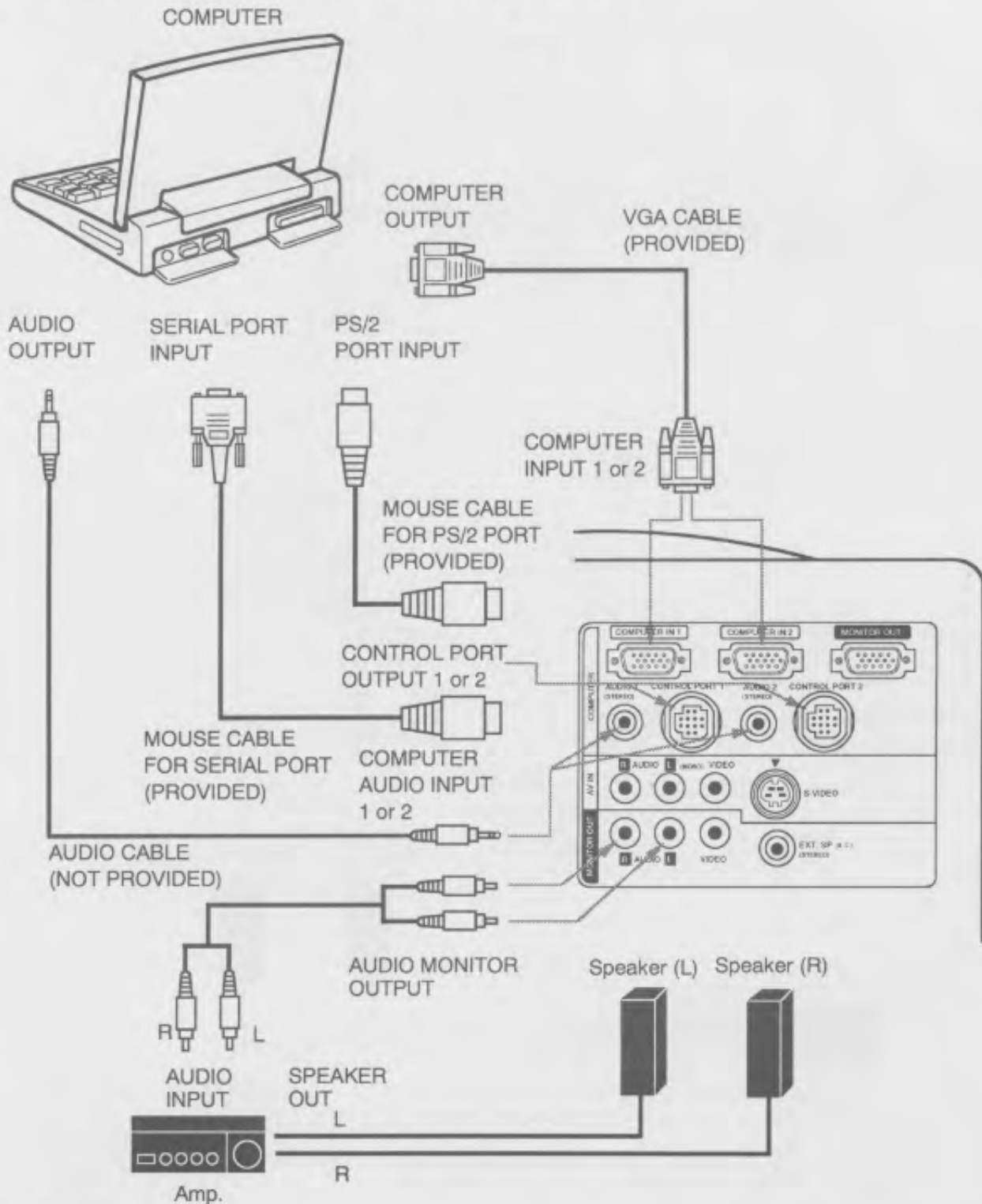

### **CAUTION**

The hook up should be done as per the above illustration. After hook up, turn on the projector, computer, in that order.

# Connecting a Macintosh PowerBook computer

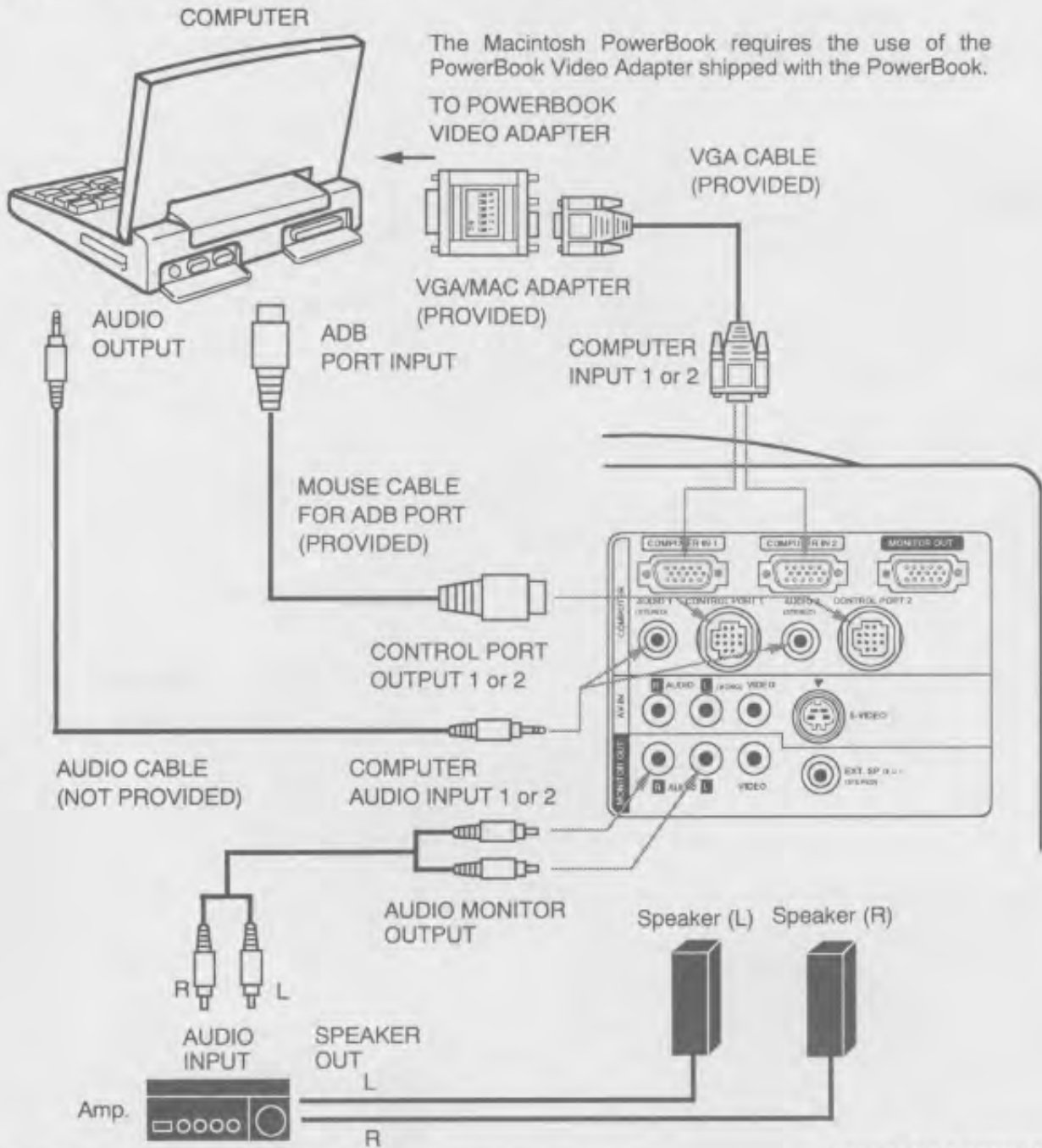

Set the slide switches as shown in the table below depending on the RESOLUTION MODE that you want to use before you turn on the projector and computer.

RESOLUTION MODE	SW1	SW2	SW3	SW4	SW5	SW6
13" MODE (640 × 480)	ON	OFF	OFF	OFF	OFF	OFF
16" MODE (832 × 624)	OFF	OFF	OFF	OFF	OFF	ON
19" MODE (1024 × 768)	OFF	OFF	OFF	ON	OFF	OFF
21" MODE (1152 × 870)	ON	ON	ON	OFF	OFF	OFF

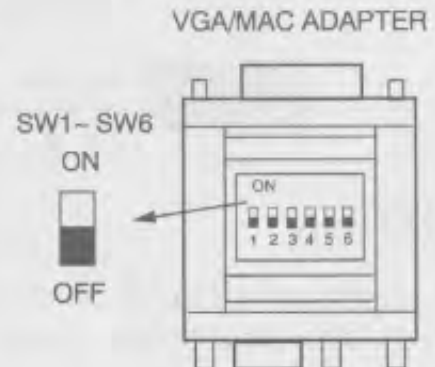

## CAUTION

The hook up should be done as per the above illustration. After hook up, turn on the projector, computer, in that order.

## **CONNECTING THE VIDEO EQUIPMENT**

### **CONNECTING TO THE AV INPUT JACKS**

Connect to the video and audio outputs of a VCR, video disc player, video camera, satellite TV tuner or other AV equipment.

- Connect audio/video outputs from external sources to these input jacks using the audio/video cable.
- If the audio signal from the AV equipment is stereo, be sure to connect the right and left channels to the respective right and left audio input jacks.
- If the external audio signal is monaural, connect it to the left jack.

### **S-VHS FORMAT VCR CONNECTION**

The AV input includes an extra video input jack marked S-VIDEO to allow connection to an S-VHS format VCR that has separate Y/C video signals. The S-VIDEO jack has priority over the VIDEO jack.

### **CONNECTING TO THE VIDEO MONITOR OUTPUT JACK**

This jack will contain the video information of the selected program source video only. If you select program source Computer 1 or Computer 2, there is no signal.

Connect video input from AV equipment to this jack by RCA cable.

Whenever the S-VIDEO signal source is viewed on the screen, the video signal available at the MONITOR OUTPUT jack will be in black and white (monochrome).

### **CONNECTING TO THE AUDIO MONITOR OUTPUT JACKS**

These jacks will contain the audio information of the selected program source being viewed on the screen (Computer 1, Computer 2 or Video 1). If you have selected program source Computer 1 the audio signal connected to the Computer 1 audio input jack will be available at the audio monitor output jacks.

- If the audio input of the audio equipment is stereo, be sure to connect the right and left channels to the respective right and left jacks.
- If the audio input of the audio equipment is monaural, connect it to the left jack.

## Connecting the Video Equipment

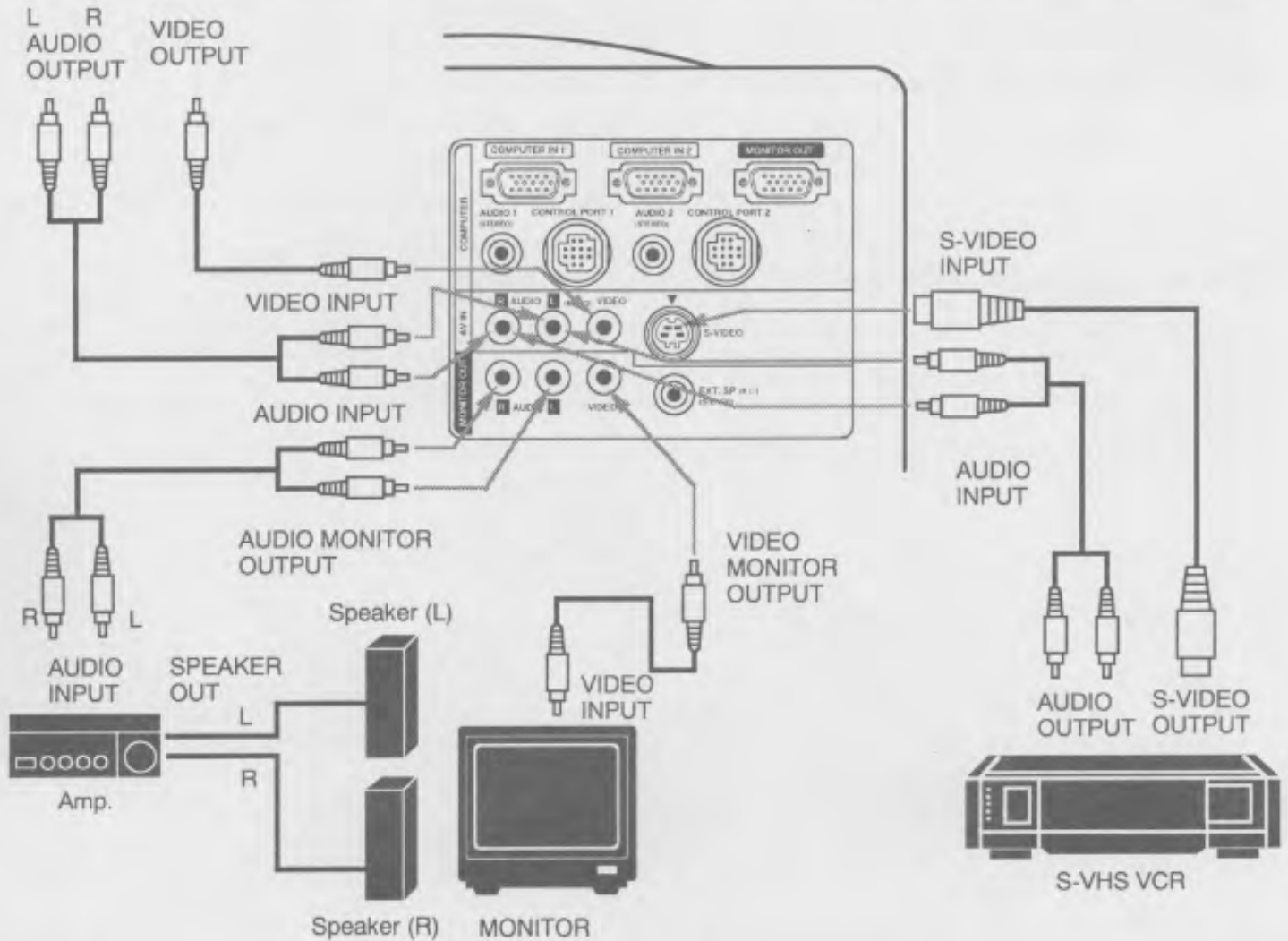

**NOTE:** The hook up should be done as per the above illustration. After hook up, turn on the projector, video equipment, in that order.



## CONNECTING AN EXTERNAL SPEAKER

### CONNECTING TO THE EXT. SP. JACK (3.5mm mini stereo type)

This jack contains the audio information of the viewed image. Use it to connect an external speaker system when using this jack. It will turn off the audio from the internal speaker.

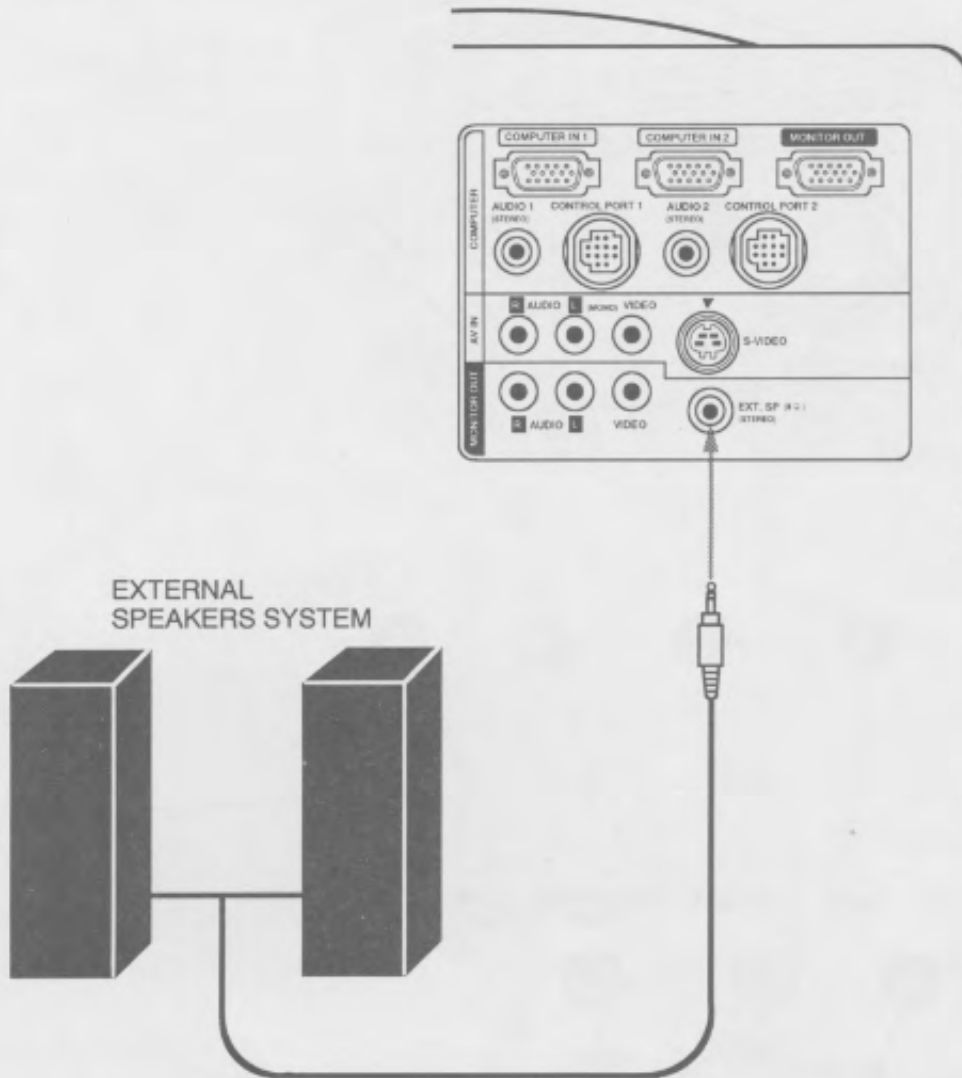

# OPERATION OF CONTROLS

## TOP OF THE PROJECTOR

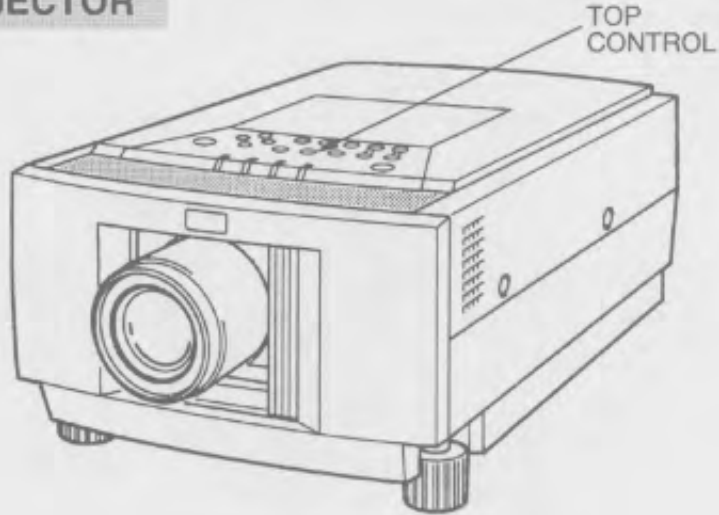

## TOP CONTROL

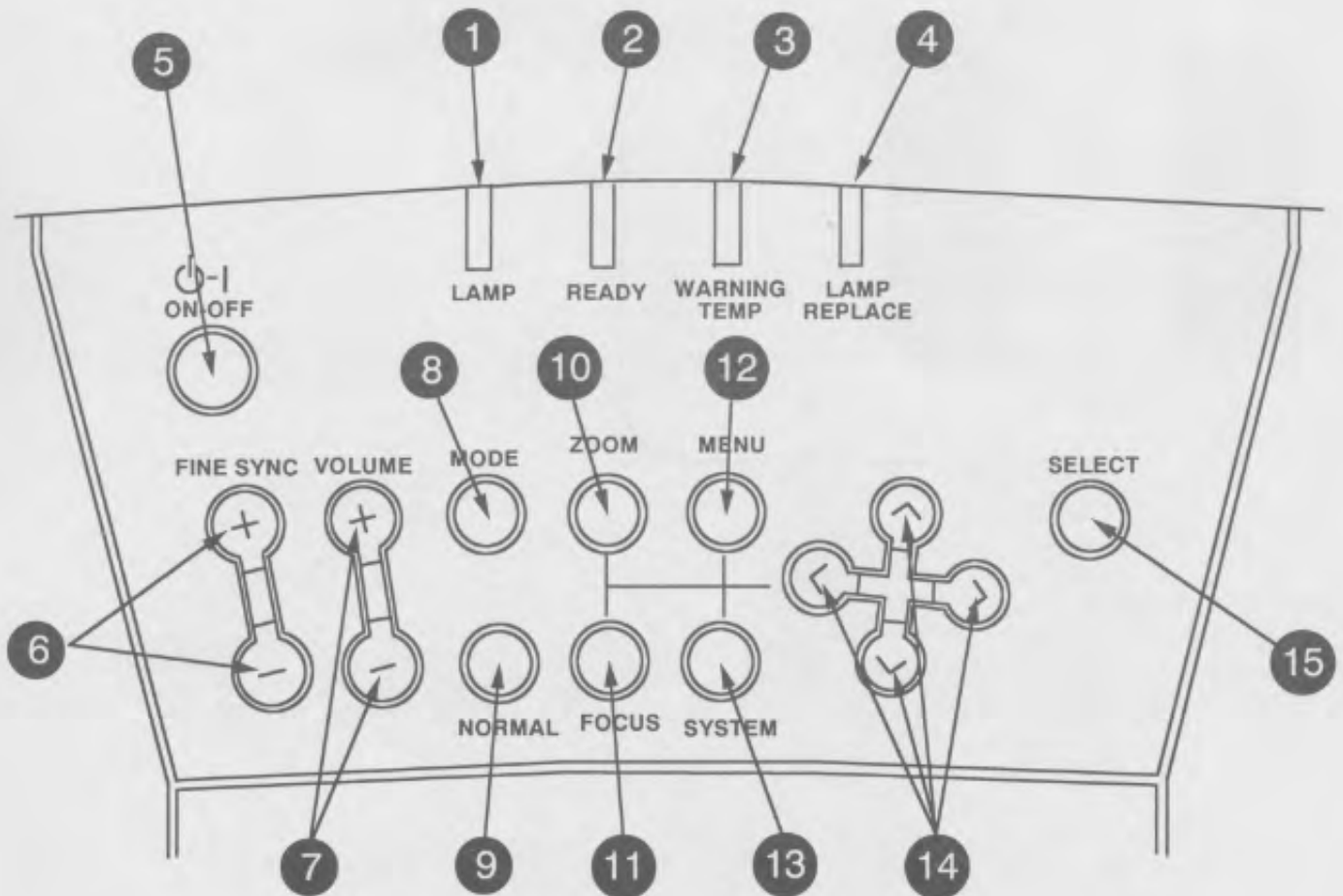

- 1 LAMP POWER INDICATOR**  
Light is dim when the projector is on.  
Light is brightened when the projector is in stand-by mode.
- 2 READY INDICATOR**  
Light is green when projector lamp is ready for turning on.
- 3 TEMPERATURE WARNING INDICATOR**  
Flashes red when internal projector temperature is too high.
- 4 LAMP REPLACEMENT INDICATOR**  
Light is orange when projection lamp is nearing end of service life.
- 5 LAMP POWER ON/OFF BUTTON**  
Used to turn projection lamp on or off.
- 6 FINE SYNC BUTTONS**  
Used to adjust fine sync.
- 7 VOLUME BUTTONS**  
Used to adjust volume.
- 8 MODE BUTTON**  
Used to select video source.  
(Computer 1, Computer 2 or Video 1 Input)
- 9 NORMAL BUTTON**  
Used to reset to normal picture adjustment preset by the factory.
- 10 ZOOM BUTTON**  
Used to select power zoom lens adjust.
- 11 FOCUS BUTTON**  
Used to select focus adjust.
- 12 MENU BUTTON**  
This button will activate the MENU operation.  
Use this button, the POINT UP/DOWN/LEFT/RIGHT buttons and the SELECT button to make adjustments to the projector's setting in MENU operation.
- 13 SYSTEM BUTTON**
  - **Computer Mode**  
Use this button, the POINT UP/DOWN/LEFT/RIGHT buttons and the SELECT button to select computer system.
  - **VIDEO Mode**  
Use this button, the POINT UP/DOWN/LEFT/RIGHT buttons and the SELECT button to select color system.
- 14 POINT UP/DOWN/LEFT/RIGHT BUTTONS**
  - To select an item on the MENU that you want to adjust. To select an item, move the arrow by pressing these buttons (UP, DOWN, LEFT or RIGHT).
  - Used to operate power zoom lens or power focus system. (Pressing these button either UP or DOWN)
- 15 SELECT BUTTON**  
This button has different functions depending on when used. This button is used to execute the item selected, to increase or decrease the values in certain items such as CONTRAST or BRIGHTNESS.

## REAR OF THE PROJECTOR

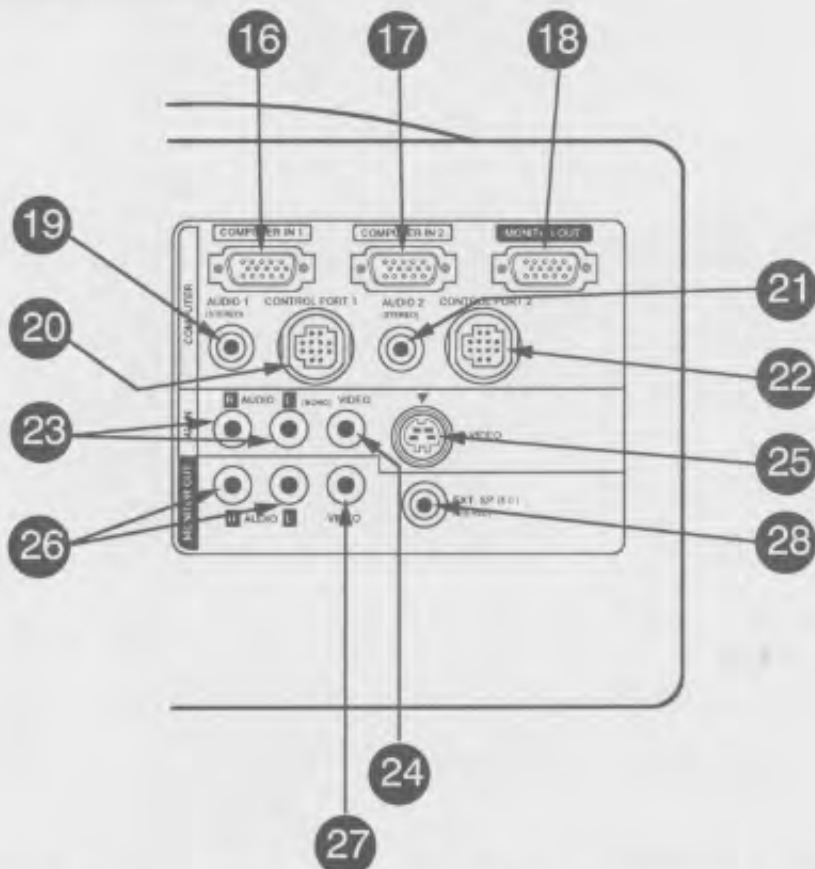

- 16 COMPUTER INPUT-1 TERMINAL**  
Used to connect a computer to the projector.
- 17 COMPUTER INPUT-2 TERMINAL**  
Used to connect a computer to the projector.
- 18 MONITOR OUTPUT TERMINAL**  
Used to connect a monitor to the projector.
- 19 COMPUTER AUDIO INPUT JACK  
mini stereo type**  
Used to connect a computer audio input to the projector.
- 20 CONTROL PORT-1 CONNECTOR**  
Used to connect a mouse cable to the projector.
- 21 COMPUTER AUDIO INPUT JACK 2  
mini stereo type**  
Used to connect a computer audio input to the projector.
- 22 CONTROL PORT-2 CONNECTOR (SERIAL PORT)**  
Used to connect a mouse cable to the projector.  
**NOTE: Control port-2 connector can be also used as serial port.**
- 23 AUDIO INPUT JACKS**  
Used to connect an audio input to the projector.
- 24 VIDEO INPUT JACK**  
Used to connect a video source to the projector.
- 25 S-VIDEO INPUT JACK**  
Used to connect a S-VHS video source to the projector.
- 26 AUDIO MONITOR OUTPUT JACKS**  
Permits audio connection to a monitor.
- 27 VIDEO MONITOR OUTPUT JACK**  
Permits video connection to a monitor.
- 28 EXT. SP. JACK (3.5 mm mini stereo type)**  
Used to connect a external speakers system.

## OPERATION OF REMOTE CONTROL

This remote control unit can be used not only as a remote control for the projector operation but also as a wireless mouse for PC. The remote control unit has a pointing pad and two click buttons. The wireless mouse function is activated when you do not adjust the setting by using the MENU operation.

**NOTE:** To use the wireless mouse function, connect the attached cable between the projector and your PC since the mouse control signal is transferred through the projector. Use the proper cable and follow the instruction as described in section "CONNECTING THE PROJECTOR" on pages 10 ~ 14 depending on your PC.



FRONT

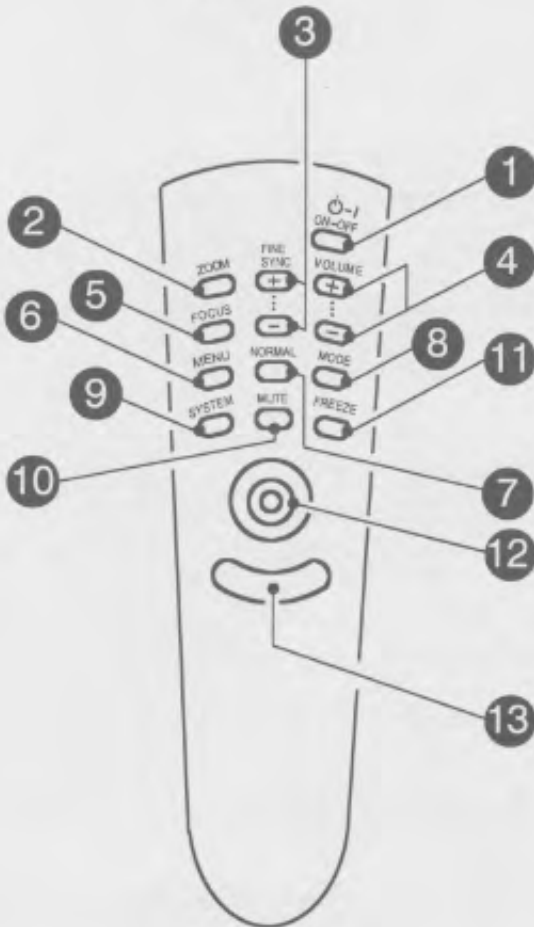

SIDE

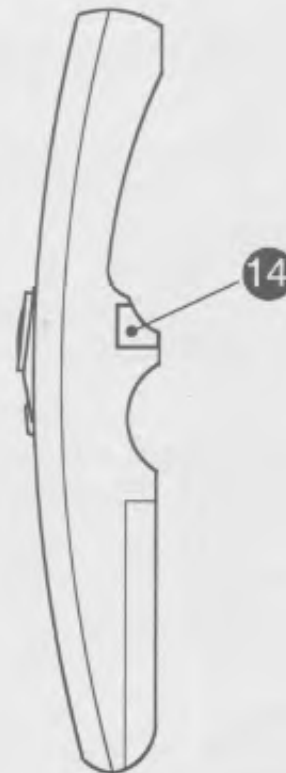

- 1 LAMP POWER ON/OFF BUTTON**  
Used to turn the projection lamp on or off.
- 2 ZOOM BUTTON**  
Used to select power zoom lens adjust.
- 3 FINE SYNC BUTTONS**  
Used to adjust fine sync.
- 4 VOLUME BUTTONS**  
Used to adjust volume.
- 5 FOCUS BUTTON**  
Used to select focus adjust.
- 6 MENU BUTTON**  
This button will activate the MENU operation. Use this button, the POINT UP/DOWN/LEFT/RIGHT button and the SELECT (REAR CLICK) button to make adjustments to the projector's setting in MENU operation.
- 7 NORMAL BUTTON**  
Use to reset to normal picture adjustment preset by the factory.
- 8 MODE BUTTON**  
Used to select video source. (Computer 1, Computer 2 or Video 1 Input)
- 9 SYSTEM BUTTON**
  - **Computer Mode**  
Use this button, the POINT UP/DOWN/LEFT/RIGHT button and the SELECT (REAR CLICK) button to select computer system.
  - **VIDEO Mode**  
Use this button, the POINT UP/DOWN/LEFT/RIGHT button and the SELECT (REAR CLICK) button to select color system.
- 10 SOUND MUTE BUTTON**  
Used to mute sound.
- 11 FREEZE BUTTON**  
Use this button to freeze on-screen image.
- 12 POINTING PAD  
(POINT UP/DOWN/LEFT/RIGHT BUTTON)**

**When in use as a remote for the projector.**  
To select an item on the MENU that you want to adjust. To select an item, move the arrow by pressing the pad upward, downward, leftward or rightward.  
Used to operate power zoom lens or power focus system by pressing the pad either upward or downward.

**When in use as a wireless mouse**  
Used to move the pointer. The pointer is moved according to the direction you are pressing.
- 13 FRONT CLICK BUTTON**  
This button has the same function as the right button in a PC mouse. Pressing this button does not affect any operation when in MENU mode.
- 14 SELECT (REAR CLICK) BUTTON**

**When in use as a remote for the projector.**  
This button has different functions depending on when used. This button is used to execute the item selected, to increase or decrease the values in certain items such as CONTRAST or BRIGHTNESS.

**When in use as a wireless mouse**  
This button has the same function as the left button in a PC mouse.

## REMOTE CONTROL BATTERY INSTALLATION

**1** Remove the battery compartment lid.



**2** Slide the batteries into the compartment.

Note: For correct polarity (+ and - terminal), be sure the battery terminals are in contact with the pins in the compartment.

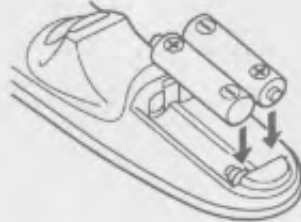

**3** Replace the compartment lid.



## USING THE REMOTE CONTROL UNIT

Point the remote control toward the projector (Receiver window) whenever pressing the buttons. Maximum operating range for the remote control is about 16.4' (5m) and 60° front and rear of the projector.

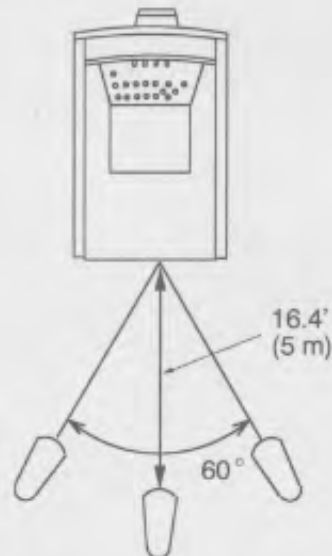
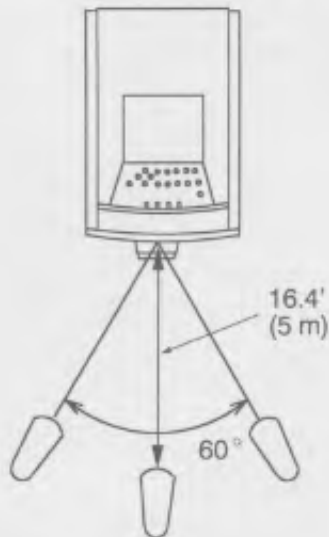

To insure safe operation, please observe the following precautions:

- Use (2) AA type alkaline batteries.
- Change two batteries at the same time.
- Do not use a new battery with a used battery.
- Avoid contact with water.
- Do not drop the remote control unit.
- If batteries have leaked on the remote control, carefully wipe the case clean and load new batteries.

## CONTROL THE PROJECTOR

The projector has two types of operation: DIRECT OPERATION and MENU OPERATION. DIRECT OPERATION allows you to operate the projector by using one button without showing the MENU. In MENU OPERATION mode, you display menus where you can adjust the projector's settings. Follow the instruction for each control.

### DIRECT OPERATION

ADJUST ITEM	TOP CONTROL OF THE PROJECTOR	REMOTE CONTROL UNIT
LAMP POWER ON/OFF	LAMP POWER ON-OFF BUTTON	LAMP POWER ON-OFF BUTTON
MODE SELECT	MODE BUTTON	MODE BUTTON
SOUND VOLUME	VOLUME (+) and ( - ) BUTTONS	VOLUME (+) and ( - ) BUTTONS
SOUND MUTE	NOT AVAILABLE	MUTE BUTTON
ZOOM	ZOOM BUTTON POINT UP/DOWN BUTTONS	ZOOM BUTTON POINT (UP/DOWN) BUTTON
FOCUS	FOCUS BUTTON POINT UP/DOWN BUTTONS	FOCUS BUTTON POINT (UP/DOWN) BUTTON
NORMAL PICTURE	NORMAL BUTTON	NORMAL BUTTON
FREEZE PICTURE	NOT AVAILABLE	FREEZE BUTTON
FINE SYNC.	FINE SYNC. (+) and ( - ) BUTTONS	FINE SYNC. (+) and ( - ) BUTTONS



## MENU OPERATION

ADJUST ITEM	TOP CONTROL OF THE PROJECTOR	REMOTE CONTROL UNIT
MODE SELECT	MENU BUTTON POINT LEFT/RIGHT BUTTONS SELECT BUTTON POINT UP/DOWN BUTTONS SELECT BUTTON	MENU BUTTON POINT (LEFT/RIGHT) BUTTON SELECT (REAR CLICK) BUTTON POINT (UP/DOWN) BUTTON SELECT (REAR CLICK) BUTTON

### 1. COMPUTER/VIDEO MODE

ADJUST ITEM	TOP CONTROL OF THE PROJECTOR	REMOTE CONTROL UNIT
SOUND SOUND VOLUME SOUND MUTE	MENU BUTTON POINT LEFT/RIGHT BUTTONS SELECT BUTTON POINT UP/DOWN BUTTONS SELECT BUTTON	MENU BUTTON POINT (LEFT/RIGHT) BUTTON SELECT (REAR CLICK) BUTTON POINT (UP/DOWN) BUTTON SELECT (REAR CLICK) BUTTON
LANGUAGE		
MENU EXIT		
SETTING AUTO RETRACT BLUE BACK DISPLAY CEILING REAR LAMP AGE	MENU BUTTON POINT LEFT/RIGHT BUTTONS SELECT BUTTON POINT UP/DOWN BUTTONS SELECT BUTTON	MENU BUTTON POINT (LEFT/RIGHT) BUTTON SELECT (REAR CLICK) BUTTON POINT (UP/DOWN) BUTTON SELECT (REAR CLICK) BUTTON

### 2. VIDEO MODE

ADJUST ITEM	TOP CONTROL OF THE PROJECTOR	REMOTE CONTROL UNIT
COLOR SYSTEM	MENU or SYSTEM BUTTON POINT LEFT/RIGHT BUTTONS SELECT BUTTON POINT UP/DOWN BUTTONS SELECT BUTTON	MENU or SYSTEM BUTTON POINT (LEFT/RIGHT) BUTTON SELECT (REAR CLICK) BUTTON POINT (UP/DOWN) BUTTON SELECT (REAR CLICK) BUTTON
PICTURE IMAGE COLOR TINT CONTRAST BRIGHTNESS SHARPNESS	MENU BUTTON POINT LEFT/RIGHT BUTTONS SELECT BUTTON POINT UP/DOWN BUTTONS SELECT BUTTON	MENU BUTTON POINT (LEFT/RIGHT) BUTTON SELECT (REAR CLICK) BUTTON POINT (UP/DOWN) BUTTON SELECT (REAR CLICK) BUTTON
PICTURE SCREEN WIDE REGULAR		

### 3. COMPUTER MODE

ADJUST ITEM	TOP CONTROL OF THE PROJECTOR	REMOTE CONTROL UNIT
<b>COMPUTER SYSTEM</b>	MENU or SYSTEM BUTTON POINT LEFT/RIGHT BUTTONS SELECT BUTTON POINT UP/DOWN BUTTONS SELECT BUTTON	MENU or SYSTEM BUTTON POINT (LEFT/RIGHT) BUTTON SELECT (REAR CLICK) BUTTON POINT (UP/DOWN) BUTTON SELECT (REAR CLICK) BUTTON
<b>PICTURE IMAGE</b> FINE SYNC TOTAL DOTS CONTRAST BRIGHTNESS	MENU BUTTON POINT LEFT/RIGHT BUTTONS SELECT BUTTON POINT UP/DOWN BUTTONS SELECT BUTTON	MENU BUTTON POINT (LEFT/RIGHT) BUTTON SELECT (REAR CLICK) BUTTON POINT (UP/DOWN) BUTTON SELECT (REAR CLICK) BUTTON
<b>PICTURE POSITION</b>	MENU BUTTON POINT LEFT/RIGHT BUTTONS SELECT BUTTON POINT LEFT/RIGHT/UP/DOWN BUTTONS SELECT BUTTON	MENU BUTTON POINT (LEFT/RIGHT) BUTTON SELECT (REAR CLICK) BUTTON POINT (LEFT/RIGHT/UP/DOWN) BUTTON SELECT (REAR CLICK) BUTTON
<b>PC ADJUSTMENT</b>	MENU BUTTON POINT LEFT/RIGHT BUTTONS SELECT BUTTON POINT UP/DOWN BUTTONS SELECT BUTTON	MENU BUTTON POINT (LEFT/RIGHT) BUTTON SELECT (REAR CLICK) BUTTON POINT (UP/DOWN) BUTTON SELECT (REAR CLICK) BUTTON
<b>AUTO IMAGE</b> FINE SYNC TOTAL DOTS POSITION	MENU BUTTON POINT LEFT/RIGHT BUTTONS SELECT BUTTON POINT UP/DOWN BUTTONS SELECT BUTTON	MENU BUTTON POINT (LEFT/RIGHT) BUTTON SELECT (REAR CLICK) BUTTON POINT (UP/DOWN) BUTTON SELECT (REAR CLICK) BUTTON
<b>PICTURE SCREEN</b> TRUE EXPAND COMPRESSED PANNING	MENU BUTTON POINT LEFT/RIGHT BUTTONS SELECT BUTTON POINT UP/DOWN BUTTONS SELECT BUTTON POINT LEFT/RIGHT/UP/DOWN BUTTONS	MENU BUTTON POINT (LEFT/RIGHT) BUTTON SELECT (REAR CLICK) BUTTON POINT (UP/DOWN) BUTTON SELECT (REAR CLICK) BUTTON POINT (LEFT/RIGHT/UP/DOWN) BUTTON

**NOTES:**

1. The MENU, once activated, will not disappear unless you have choose MENU EXIT operation. If you switch to DIRECT operation by pressing a DIRECT operation button while in MENU mode, the menus will disappear and the MENU operation will end.
2. You can use the REMOTE CONTROL UNIT or the TOP CONTROL OF THE PROJECTOR to operate the MENU operation.

# USING THE PROJECTOR

## TO TURN ON THE PROJECTOR

Connect the projector to a video source (Computer, VCR, Video Camera, Video Disc Player, etc.) using the appropriate terminals on the rear of the projector (See "CONNECTING THE PROJECTOR" section on pages 10-17).

Connect the projector's AC power cord into a wall outlet and turn the MAINS ON/OFF switch (located on the rear of the projector) to the ON position. The LAMP POWER indicator will light RED, the READY indicator will light GREEN.

Press the LAMP POWER ON/OFF button on the remote control unit or on the projector to ON. The LAMP POWER indicator light will dim and the cooling fans will operate. The count-down display appears on the screen and the count-down starts (20-19-18-...1). The signal from the video source appears after 30 seconds.



### CAUTION:

**THIS PROJECTOR USES AN UHP TYPE LAMP. TO EXTEND THE LIFE OF THE LAMP, ONCE YOU HAVE TURNED IT ON, WAIT AT LEAST 5 MINUTES BEFORE TURNING IT OFF.**

**NOTE:** TEMPERATURE WARNING INDICATOR flashes red, the projector will be automatically turned off. Wait at least 5 minutes before turning the projector on.

If the TEMPERATURE WARNING INDICATOR continues to flash, follow the procedures below:

- (1). Press LAMP POWER ON/OFF button to OFF.
- (2). Check the air filter for dust accumulation.
- (3). Remove dust with vacuum cleaner (See "AIR FILTER CARE AND CLEANING" section on page 47.)
- (4). Press LAMP POWER ON/OFF button to ON.

If the TEMPERATURE WARNING INDICATOR still continues to flash, call your authorized dealer or service station.

## TO TURN OFF THE PROJECTOR

Press the LAMP POWER ON/OFF button on the remote control unit or on the projector. The "Power off ?" appears on the screen. Press again the LAMP POWER ON/OFF button to turn OFF the projector. The LAMP POWER indicator will light bright and READY indicator will turn off. The cooling fans will operate for 1 minute after the projector is turned off. (During this "cooling down" period, the projector cannot be turned on.) The READY indicator will light green again and the projector may be turned on by pressing the LAMP POWER ON/OFF button.

Power off ?

## DIRECT OPERATION

### MODE SELECT

Press the MODE button (located on remote control unit or on the projector) to select Computer 1, Computer 2 or Video 1 Input. The "Computer 1", "Computer 2" or "Video 1" display will appear on the screen for a few seconds.

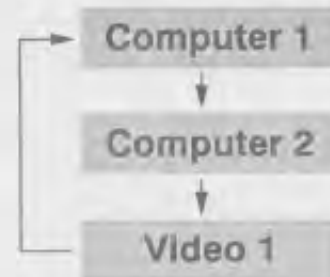

### SOUND VOLUME ADJUSTMENT

Press the VOLUME buttons (located on remote control unit or on the projector) to adjust the volume. The volume display will appear on the screen for a few seconds.

Pressing volume (+) to increase volume and increase the number on the display.

Pressing volume (-) to decrease volume and decrease the number on the display.

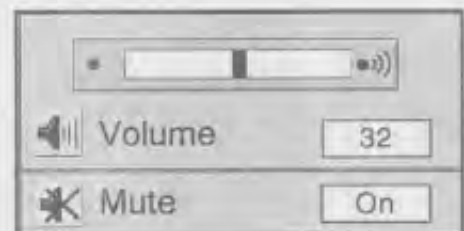

### SOUND MUTE FUNCTION

Pressing the MUTE button on the remote control unit to mute audio. Press the MUTE button again to restore audio to its previous level. The mute display will appear on the screen for a few seconds.

### ZOOM ADJUSTMENT

Press the ZOOM button (located on remote control unit or on the projector) and press POINT UP/DOWN button(s) to obtain your desired picture size. The Zoom display will appear on the screen for a few seconds.

For a larger picture, press (UP) and for a smaller picture, press (DOWN).

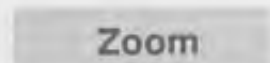

### FOCUS ADJUSTMENT

Press the FOCUS button (located on remote control unit or on the projector) and press POINT UP/DOWN button(s) to obtain a sharper, crisper picture. The Focus display will appear on the screen for a few seconds.

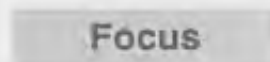

### NORMAL PICTURE FUNCTION

The normal picture level is factory preset on the projector and can be restored anytime by pressing the NORMAL button (located on remote control unit or on the projector). The "Normal" display will appear on the screen for a few seconds.

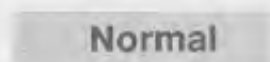

### FREEZE PICTURE FUNCTION

Press the FREEZE button on the remote control unit, and the still picture will remain on-screen. This function is cancelled when the FREEZE button is pressed again or any other function button is pressed.

**NOTE:** Your computer or video equipment is not affected by this function, and will continue to run.

### FINE SYNC ADJUSTMENT

Press the FINE SYNC (+) or (-) buttons (located on remote control unit or on the projector) to eliminate flicker from the display on computer mode. The Fine sync display will be displayed on the screen. Press the MENU button (located on remote control unit or on the projector). The Fine sync displays will disappear.

**NOTE:** The projector may not reproduce a proper image for some SXGA signals. Since SXGA (1280 × 1024) image is converted to XGA (1024 × 768) image by partial scan, some lines and dots of the image do not appear. The flicker on this compressed SXGA image cannot be eliminated even though you try to make a FINE SYNC adjustment.



## MENU OPERATION

In MENU OPERATION mode, you display menus where you can adjust the projector's settings. You can use the TOP CONTROL OF THE PROJECTOR or the REMOTE CONTROL UNIT.

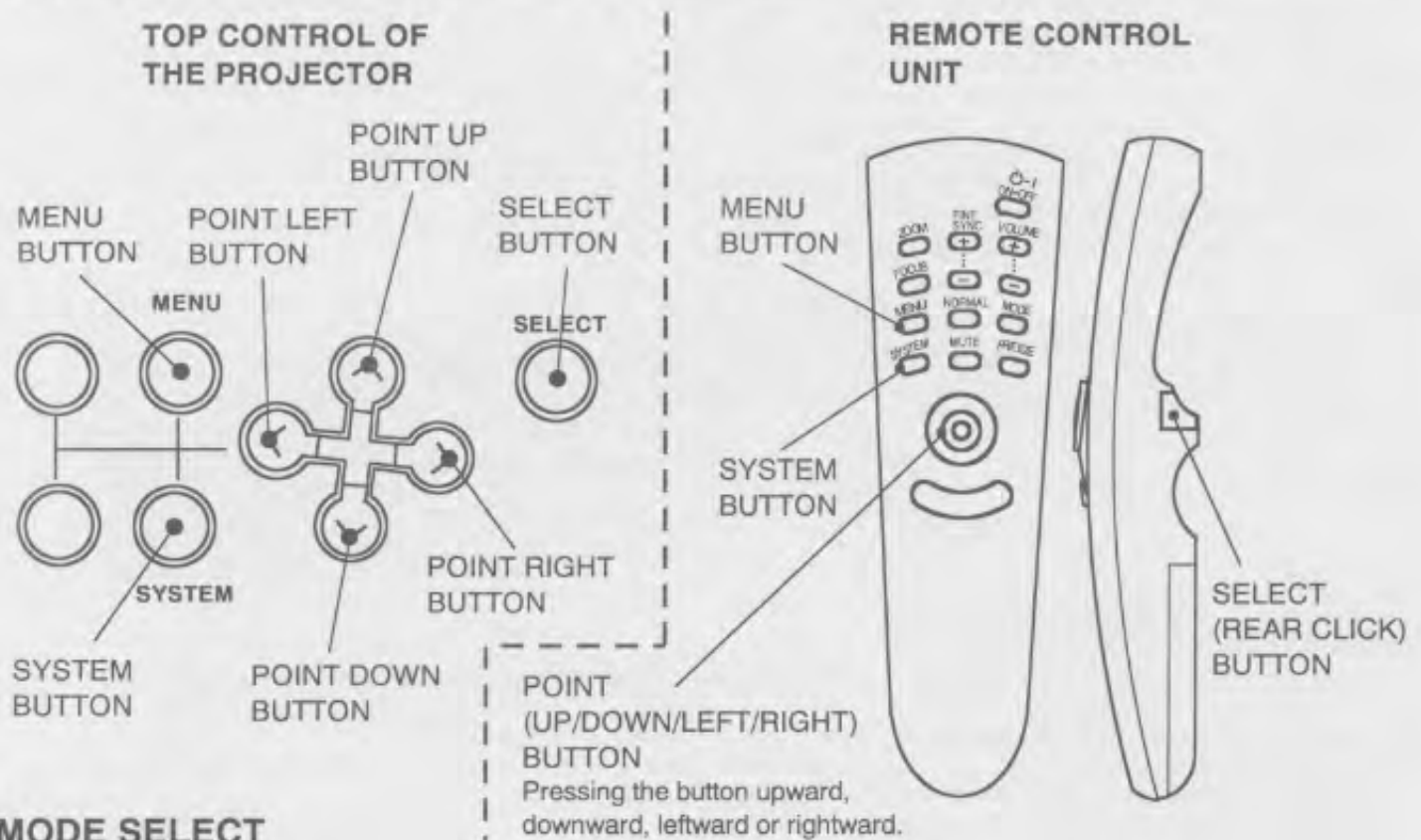

## MODE SELECT

You can select a mode used in the MENU among computer 1, computer 2 and video 1.

1. Press the MENU BUTTON and the MAIN MENU DISPLAY dialog box will appear.
2. Press the POINT LEFT/RIGHT BUTTON(s) to select Computer or Video and press the SELECT (REAR CLICK) BUTTON. Another dialog box MODE DISPLAY will appear.
3. Press the POINT DOWN BUTTON and a red arrow will appear.
4. Move the arrow to the mode you want (computer 1, computer 2 or video 1) to use by pressing the POINT UP/DOWN BUTTON(s) and then press the SELECT (REAR CLICK) BUTTON.

### MAIN MENU DISPLAY



### MAIN MENU DISPLAY

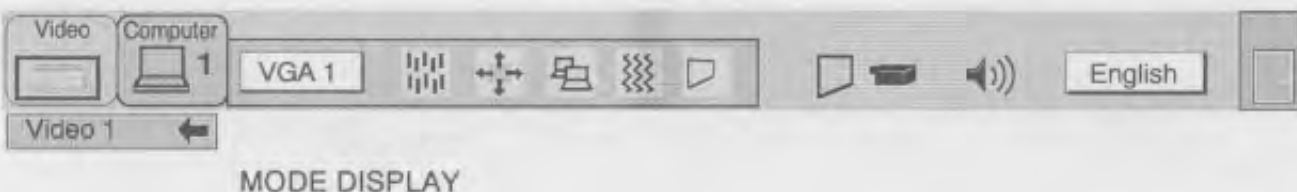

## SOUND ADJUSTMENT

You can adjust the sound volume and sound mute used in the MENU.

1. Press the MENU BUTTON and the MAIN MENU DISPLAY dialog box will appear.
2. Press the POINT LEFT/RIGHT BUTTON(s) to select SOUND and press the SELECT (REAR CLICK) BUTTON. Another dialog box SOUND ADJUST DISPLAY will appear.
3. Press the POINT DOWN BUTTON and a red arrow will appear.
4. Move the arrow to an adjusting item you want to adjust by pressing the POINT UP/DOWN BUTTON(s).
5. To increase the sound volume, point the arrow to  $\triangle$  and then press the SELECT (REAR CLICK) BUTTON. To decrease the sound volume, point the arrow to  $\nabla$  and then press the SELECT (REAR CLICK) BUTTON.
6. To mute the sound, point the arrow to Mute and then press the SELECT (REAR CLICK) BUTTON. The mute display is changed On from Off and sound to mute.
7. To quit the MENU, point to Quit and then press the SELECT (REAR CLICK) BUTTON.



## LANGUAGE ADJUSTMENT

You can select a language used in the MENU among English, German, French, Italian, Spanish and Japanese.

1. Press the MENU BUTTON and the MAIN MENU DISPLAY dialog box will appear.
2. Press the POINT LEFT/RIGHT BUTTON(s) to select LANGUAGE and press the SELECT (REAR CLICK) BUTTON. Another dialog box LANGUAGE SETTING DISPLAY will appear.
3. Press the POINT DOWN BUTTON and a red arrow will appear.
4. Move the arrow to the language you want to use by pressing the POINT UP/DOWN BUTTON(s) and then press the SELECT (REAR CLICK) BUTTON.
5. The setting is permanently held even if the MAIN ON/OFF is switched off.

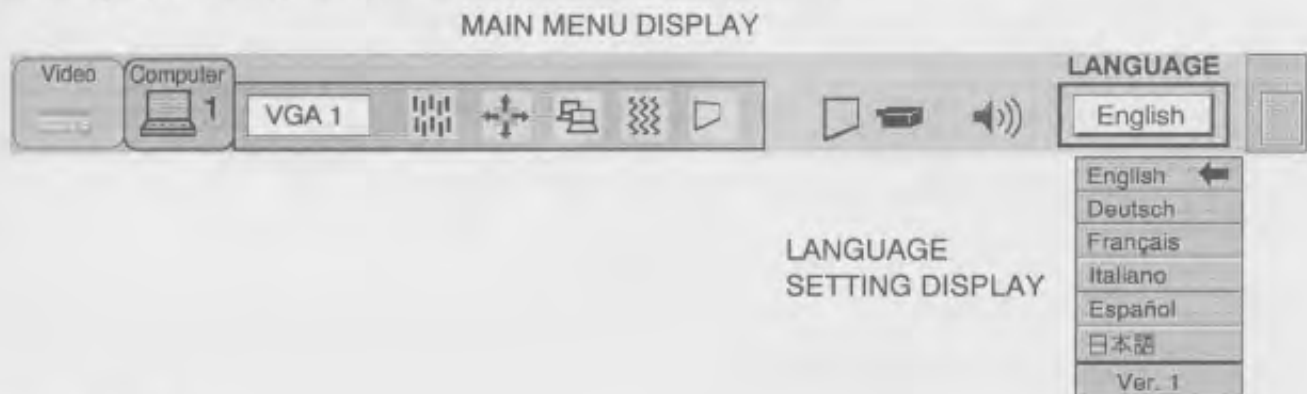

## MENU EXIT

To close the MENU display, press the POINT RIGHT BUTTON to select right end ICON and then press the SELECT (REAR CLICK) BUTTON.

NOTE: Press the MENU BUTTON during the appearing of the MENU display on the screen, the MENU display is disappeared.

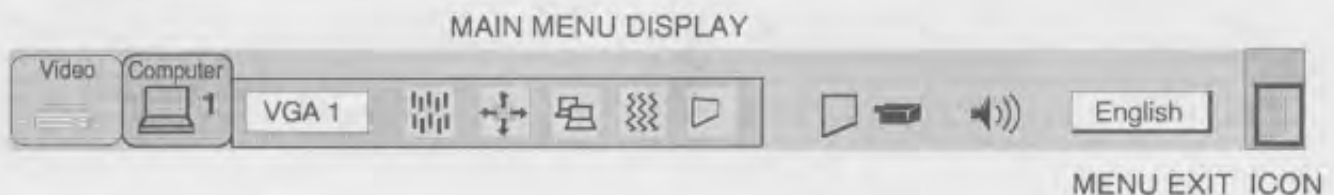

## COLOR SYSTEM SELECT (VIDEO MODE)

This projector is compatible with the four major broadcast video standards: PAL, SECAM, NTSC or NTSC 4.43 (COLOR SYSTEMS). When the color system is set to "Auto" position, this projector can receive color programs from one of the 4 systems (PAL, SECAM, NTSC or NTSC 4.43), automatically. However, if the video signal is poor, the projector may not reproduce the proper video image. In this case, a specific broadcast format should be chosen by color system select.

1. Connect the video equipment and the PROJECTOR, and turn them on.
2. Set MODE SELECT to "VIDEO MODE".
3. Press the MENU BUTTON and the MAIN MENU DISPLAY dialog box will appear.
4. Press the POINT LEFT/RIGHT BUTTON(s) to select SYSTEM and press the SELECT (REAR CLICK) BUTTON. Another dialog box COLOR SYSTEM DISPLAY will appear. The current COLOR SYSTEM is displayed in the system window.
5. Press the POINT DOWN BUTTON and a red arrow will appear.
6. If you want to change the COLOR SYSTEM from the current one, move the arrow by press the POINT UP/DOWN BUTTON(s) to the system that you want to select and then press the SELECT (REAR CLICK) BUTTON and changed the color mode.
7. The setting changed is temporarily effective until you turn off the MAIN ON/OFF switch.



## SIMPLY METHOD

1. Press the SYSTEM BUTTON. COLOR SYSTEM DISPLAY dialog box will appear.
2. Press the POINT DOWN BUTTON and a red arrow will appear.
3. If you want to change the COLOR SYSTEM from the current one, move the arrow by press the POINT UP/DOWN BUTTON(s) to the system that you want to select and then press the SELECT (REAR CLICK) BUTTON and changed the color mode.

## PICTURE IMAGE ADJUSTMENT (VIDEO MODE)

Although picture adjustments have been preset at the factory to our standards, you may want to change the setting.

1. Press the MENU BUTTON and the MAIN MENU DISPLAY dialog box will appear.
2. Press the POINT LEFT/RIGHT BUTTON(s) to select IMAGE and press the SELECT (REAR CLICK) BUTTON. Another dialog box IMAGE ADJUST DISPLAY will appear. This shows the current picture settings.
3. In this dialog box, you can adjust to increase or decrease the setting levels.
4. Press the POINT DOWN BUTTON and a red arrow will appear.
5. Move the arrow to an adjusting item you want to adjust by pressing the POINT UP/DOWN BUTTON(s).
6. To increase the level, point the arrow to  $\triangle$  and then press the SELECT (REAR CLICK) BUTTON. To decrease the level, point the arrow to  $\nabla$  and then press the SELECT (REAR CLICK) BUTTON.
7. You may want to store the settings to the memory so that you can recall them later. To store the settings, move the arrow to Stored and then press the SELECT (REAR CLICK) BUTTON. When you have stored the settings, you will see "OK ?" as a confirmation.
8. Move the arrow to Yes and then press the SELECT (REAR CLICK) BUTTON. The stored settings are permanently kept even if the MAIN ON/OFF is switched off.
9. To quit the MENU, move the arrow to Quit and then press the SELECT (REAR CLICK) BUTTON.
10. If you do not want to store the settings, move the arrow to Quit and then press the SELECT (REAR CLICK) BUTTON. The settings changed are temporarily effective until you turn off the MAIN ON/OFF switch.
11. To recall the settings you have stored, move the arrow to Reset and then press the SELECT (REAR CLICK) BUTTON. When you have reset the settings, you will see "OK ?" as a confirmation. Move the arrow to Yes and then press the SELECT (REAR CLICK) BUTTON. You can adjust the settings again if needed.

NOTE: "TINT" will be skipped during in the PAL and SECAM mode.

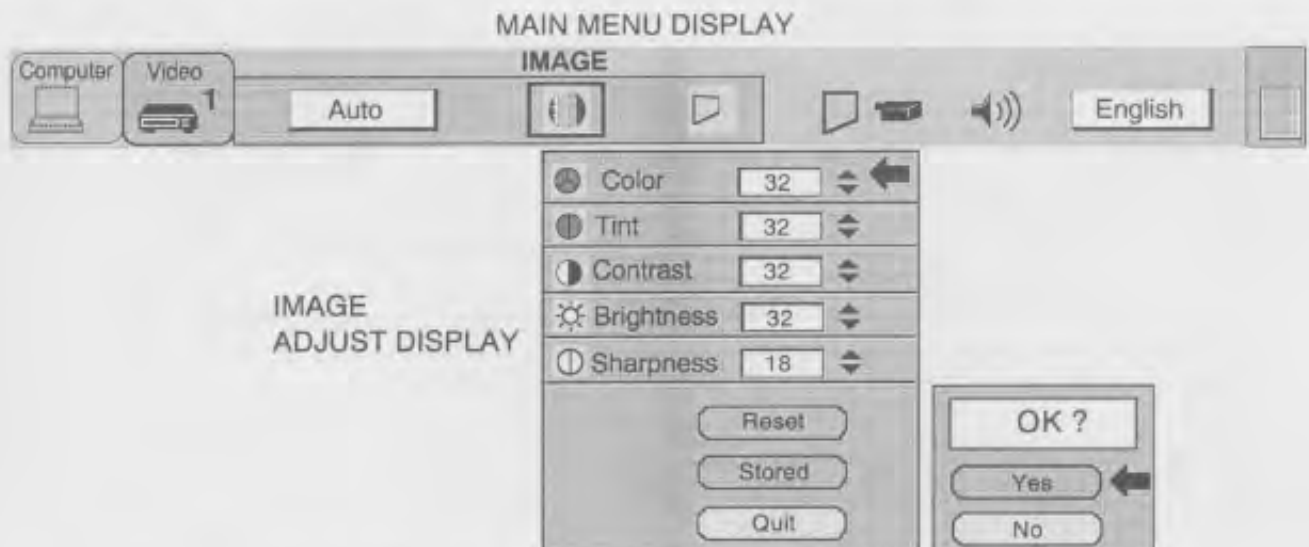

TABLE OF PICTURE IMAGE ADJUSTMENT

<b>COLOR</b>	DECREASES	0 $\longleftrightarrow$ 63	INCREASES
<b>TINT</b>	MORE PURPLE	0 $\longleftrightarrow$ 63	MORE GREEN
<b>CONTRAST</b>	LIGHTER	0 $\longleftrightarrow$ 63	DEEPER
<b>BRIGHTNESS</b>	DARKER	0 $\longleftrightarrow$ 63	BRIGHTER
<b>SHARPNESS</b>	SOFTER	0 $\longleftrightarrow$ 31	SHARPER



## PICTURE SCREEN ADJUSTMENT (VIDEO MODE)

This projector has a Wide image function, which enables you to view a wider video image.

### **WIDE image function**

This projector is designed to project a normal video image (with 4 x 3 aspect ratio). In addition, with the WIDE function, the projector can project a wider video image by compressing 4 x 3 image. This feature may be used by those who want to enjoy watching a movie with a cinemascope image. You can switch to either WIDE or REGULAR screen mode.

1. Press the MENU BUTTON and the MAIN MENU DISPLAY dialog box will appear.
2. Press the POINT LEFT/RIGHT BUTTON(s) to select SCREEN and press the SELECT (REAR CLICK) BUTTON. Another dialog box SCREEN ADJUST DISPLAY will appear.
3. Press the POINT DOWN BUTTON and a red arrow will appear.
4. To switch to "Wide" mode, move the arrow to Wide by pressing the POINT UP/DOWN BUTTON(s) and then press the SELECT (REAR CLICK) BUTTON.
5. To switch to "Regular" mode, move the arrow to Regular by pressing the POINT UP/DOWN BUTTON(s) and then press the SELECT (REAR CLICK) BUTTON.
6. The "Wide" settings is temporarily effective until you turn off the MAIN ON/OFF switch.

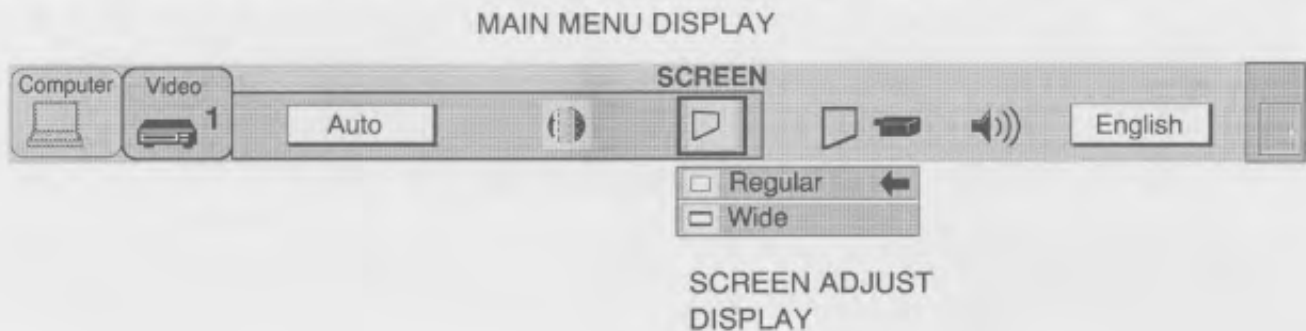

## COMPUTER SYSTEM SELECT (COMPUTER MODE)

This projector is designed to accept different types of computer display signals based on VGA, SVGA, XGA or SXGA (See "COMPATIBLE COMPUTER SPECIFICATIONS" on the next page). If you set MODE SELECT to "COMPUTER", the projector will automatically process the incoming signal and project the proper image without any special setting. Although this will work in most cases, you may be required to manually set the projector for some computer signals. If the computer image is not reproduced properly, try the following procedure and switch to the computer display mode that you want to use.

1. Connect the COMPUTER and the PROJECTOR, and turn them on.
2. Set MODE SELECT to "COMPUTER MODE (1 or 2)". This shows the current display mode initially detected by the projector in the system window. And "Current mode" display appears.

NOTE: 1. If the projector cannot discriminate or detect the input signal from the computer, the "Go PC adj." display appears.

NOTE: 2. If no input signal from the computer, the "No signal" display appears on the screen.

3. Press the MENU BUTTON and the MAIN MENU DISPLAY dialog box will appear.
4. Press the POINT LEFT/RIGHT BUTTON(s) to select SYSTEM and press the SELECT (REAR CLICK) BUTTON. Another dialog box COMPUTER SYSTEM DISPLAY will appear.
5. Press the POINT DOWN BUTTON and a red arrow will appear.
6. If you want to change the display mode from the current one, move the arrow by press the POINT UP/DOWN BUTTON(s) to select one of the modes.
7. Press the SELECT (REAR CLICK) BUTTON and changed the display mode.
8. To quit the MENU, move the arrow to Quit and then press the SELECT (REAR CLICK) BUTTON.

### MAIN MENU DISPLAY

The diagram illustrates the navigation process through the projector's menu system. At the top, the 'MAIN MENU DISPLAY' shows a 'Video' tab and a 'Computer' tab with a '1' indicator. The 'SYSTEM' menu is open, showing 'VGA 1' selected. Below this, the 'COMPUTER SYSTEM DISPLAY' dialog box is shown in three stages: 1. Initial state with 'VGA1' selected and a red arrow pointing left. 2. State after selecting 'Mode 1'. 3. State after selecting 'Mode 2'. A 'Quit' button is visible at the bottom of each dialog box. To the left, the 'CURRENT MODE DISPLAY' shows settings for 'Current mode', 'H-Sync freq.' (36.5), 'V-Sync freq.' (60.0), and 'Polarity' (H+V+). A note explains that a black refresh icon indicates that computer system mode will be available on the next page.

### SIMPLY METHOD

1. Press the SYSTEM BUTTON. COMPUTER SYSTEM DISPLAY dialog box will appear.
2. Press the POINT DOWN BUTTON and a red arrow will appear.
3. If you want to change the display mode from the current one, move the arrow by press the POINT UP/DOWN BUTTON(s) to select one of the modes.
4. Press the SELECT (REAR CLICK) BUTTON and changed the display mode.
5. To quit the MENU, move the arrow to Quit and then press the SELECT (REAR CLICK) BUTTON.

### PC ADJUSTMENT

This is a special function that may be used when a computer image is not reproduced properly. (See the pages 38 ~ 41 for more detail.)

## COMPATIBLE COMPUTER SPECIFICATIONS

ON-SCREEN DISPLAY	RESOLUTION	H-Freq. (kHz)	V-Freq. (Hz)	ON-SCREEN DISPLAY	RESOLUTION	H-Freq. (kHz)	V-Freq. (Hz)
VGA1	640 × 480	31.47	59.88	XGA3	1024 × 768	60.08	75.10
VGA2	720 × 400	31.47	70.09	XGA4	1024 × 768	56.47	70.06
VGA3	640 × 400	31.47	70.09	XGA5	1024 × 768	60.31	74.92
VGA4	640 × 480	37.86	74.38	XGA6	1024 × 768	48.50	60.02
VGA5	640 × 480	37.86	72.81	XGA7	1024 × 768	44.00	54.58
VGA6	640 × 480	31.70	61.91	XGA8	1024 × 768	63.48	79.35
MAC LC13	640 × 480	34.97	66.60	XGA9	1024 × 768	36.00	87.17
MAC 13	640 × 480	35.00	66.67	MAC19	1024 × 768	60.24	75.08
PC98	640 × 400	24.83	56.42	SXGA1	1152 × 864	64.20	70.40
FM TOWNS	640 × 400	24.38	55.40	SXGA2	1280 × 1024	62.50	58.60
SVGA1	800 × 600	35.21	56.33	SXGA3	1280 × 1024	63.98	60.02
SVGA2	800 × 600	37.88	60.32	SXGA4	1280 × 1024	63.34	59.98
SVGA3	800 × 600	46.92	75.08	SXGA5	1280 × 1024	63.74	60.01
SVGA4	800 × 600	48.32	76.33	SXGA6	1280 × 1024	71.57	67.20
SVGA5	800 × 600	48.01	71.98	SXGA7	1280 × 1024	81.12	75.99
SVGA6	800 × 600	37.90	61.03	SXGA8	1280 × 1024	81.18	75.99
SVGA7	800 × 600	34.50	55.38	SXGA11	1152 × 900	61.78	66.13
SVGA8	800 × 600	38.00	60.51	SXGA12	1152 × 900	71.73	76.21
SVGA9	800 × 600	38.60	60.31	SXGA13	1280 × 1024	50.00	86.00
SVGA10	800 × 600	47.90	71.92	SXGA14	1280 × 1024	50.00	94.00
SVGA11	800 × 600	32.70	51.09	MAC21	1152 × 870	68.68	75.06
SVGA12	800 × 600	38.00	60.51	MAC	1280 × 960	75.08	75.08
MAC 16	832 × 624	49.72	74.55	MAC	1280 × 1024	80.00	75.08
XGA1	1024 × 768	48.36	60.00				
XGA2	1024 × 768	56.28	70.26				

Specifications are subject to change without notice.

**NOTE:** Basically this projector (LC-XGA970U) can accept the signal from all computers with the above mentioned V, H-Frequency and less than 135 MHz of Dot Clock.

## PICTURE IMAGE ADJUSTMENT (COMPUTER MODE)

Although picture adjustments have been preset at the factory to our standards, you may want to change the setting.

1. Press the MENU BUTTON and the MAIN MENU DISPLAY dialog box will appear.
2. Press the POINT LEFT/RIGHT BUTTON(s) to select IMAGE and press the SELECT (REAR CLICK) BUTTON. Another dialog box IMAGE ADJUST DISPLAY will appear. This shows the current picture settings.
3. In this dialog box, you can adjust to increase or decrease the setting levels
4. Press the POINT DOWN BUTTON and a red arrow will appear.
5. Move the arrow to an adjusting item you want to adjust by pressing the POINT UP/DOWN BUTTON(s).
6. To increase the level, point the arrow to  $\Delta$  and then press the SELECT (REAR CLICK) BUTTON. To decrease the level, point the arrow to  $\nabla$  and then press the SELECT (REAR CLICK) BUTTON.
7. You may want to store the settings to the memory so that you can recall them later. To store the settings, move the arrow to Stored and then press the SELECT (REAR CLICK) BUTTON. When you have stored the settings, you will see "OK ?" as a confirmation.
8. Move the arrow to Yes and then press the SELECT (REAR CLICK) BUTTON. The stored settings are permanently held even if the MAIN ON/OFF is switched off.
9. To quit the MENU, move the arrow to Quit and then press the SELECT (REAR CLICK) BUTTON.
10. If you do not want to store the settings, move the arrow to Quit and then press the SELECT (REAR CLICK) BUTTON. The settings changed are temporarily effective until you turn off the MAIN ON/OFF switch.
11. To recall the settings you have stored, move the arrow to Reset and then press the SELECT (REAR CLICK) BUTTON. When you have reset the settings, you will see "OK ?" as a confirmation. Move the arrow to Yes and then press the SELECT (REAR CLICK) BUTTON. You can adjust the settings again if needed.

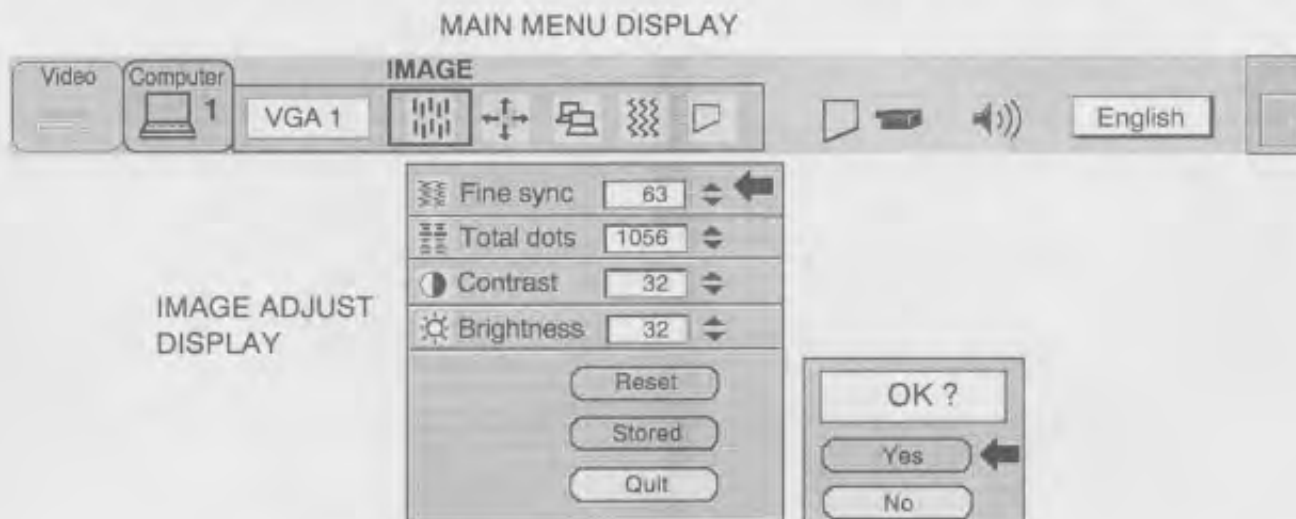
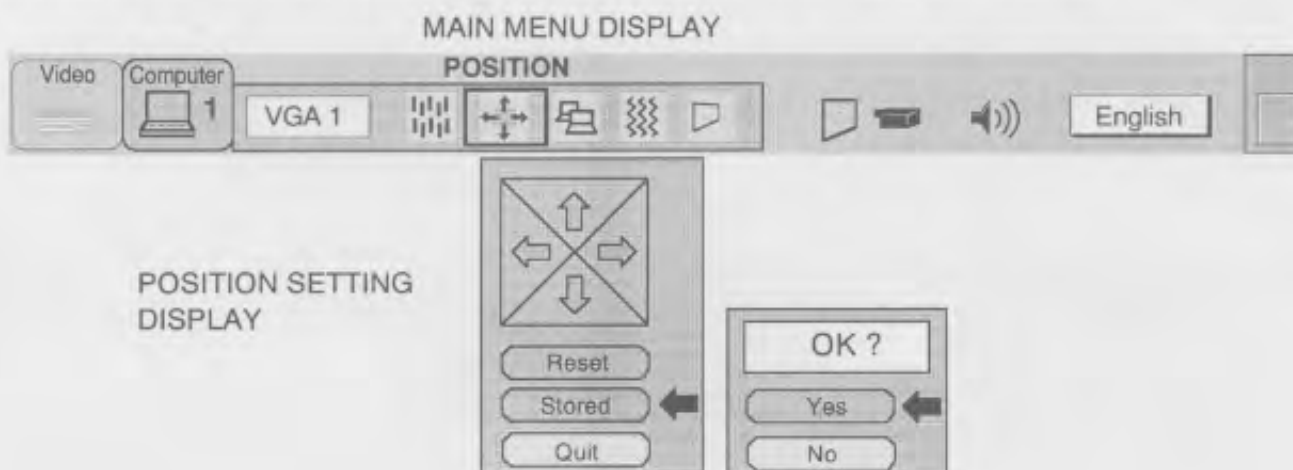

TABLE OF PICTURE IMAGE ADJUSTMENT

<b>FINE SYNC</b>	Adjust of the fine sync to eliminate flicker from the display.	0 $\longleftrightarrow$ 127
<b>TOTAL DOTS</b>	The number of the total dots in one horizontal period. Adjust the number to match your PC image.	
<b>CONTRAST</b>	LIGHTER 0 $\longleftrightarrow$ 63 DEEPER	
<b>BRIGHTNESS</b>	DARKER 0 $\longleftrightarrow$ 63 BRIGHTER	

## PICTURE POSITION ADJUSTMENT (COMPUTER MODE)

1. Press the MENU BUTTON and the MAIN MENU DISPLAY dialog box will appear.
2. Press the POINT LEFT/RIGHT BUTTON(s) to select POSITION and press the SELECT (REAR CLICK) BUTTON. Another dialog box POSITION SETTING DISPLAY will appear.
3. Press the POINT DOWN BUTTON and a red arrow will appear.
4. Move the arrow to a direction (←, →, ↑ or ↓) by pressing the POINT LEFT/RIGHT/UP/DOWN BUTTON(s) and press the SELECT (REAR CLICK) BUTTON to change the picture position.
5. You may want to store the settings to the memory so that you can recall them later. To store the settings, move the arrow to Stored and then press the SELECT (REAR CLICK) BUTTON. When you have stored the settings, you will see "OK ?" as a confirmation.
6. Move the arrow to Yes and then press the SELECT (REAR CLICK) BUTTON. The stored settings are permanently held even if the MAIN ON/OFF is switched off.
7. To quit the MENU, move the arrow to Quit and then press the SELECT (REAR CLICK) BUTTON.
8. If you do not want to store the settings, move the arrow to Quit and then press the SELECT (REAR CLICK) BUTTON. The settings changed are temporarily effective until you turn off the MAIN ON/OFF switch.
9. To recall the settings you have stored, move the arrow to Reset and then press the SELECT (REAR CLICK) BUTTON. When you have reset the settings, you will see "OK ?" as a confirmation. Move the arrow to Yes and then press the SELECT (REAR CLICK) BUTTON. You can adjust the settings again if required.



## PC ADJUSTMENT

This projector can automatically detect the most display signals in most personal computers currently existing in the market. However, some computers output a special signal format which is different from the standard ones and may not be detected by this projector. If this case happens, the projector cannot reproduce a proper image, often recognized as a flickering picture, a non-synchronized picture, a non-centered picture or a skewed picture.

To project a proper image for those non-standard formats, this projector provides PC ADJUST, in which you can precisely adjust several parameters to match the input signal format. The projector has eight independent memory areas that you can store the parameter settings you have made. Therefore, you can recall the setting for a specific computer when you need it.

1. Press the MENU BUTTON and the MAIN MENU DISPLAY dialog box will appear.
2. Press the POINT LEFT/RIGHT BUTTON(s) to select PC ADJUST and press the SELECT (REAR CLICK) BUTTON. Another dialog box "Where to reserve" will appear.
3. In this dialog box, you will select one of the memory areas shown as "Mode 1" to "Mode 8". If the parameters have been previously set and stored to the memory, the status "Stored" will appear on a corresponding row. If not, "Free" will appear.
4. Press the POINT DOWN BUTTON and a red arrow will appear.
5. Move the arrow to one of the "Modes" (Free position) that you want to store by pressing the POINT UP/DOWN BUTTON(s). Press the SELECT (REAR CLICK) BUTTON to select it.

NOTE; If all modes are occupied, no new PC parameter data can be stored. In this case, clear the PC parameter data using the Mode free Function.



6. Another dialog box "PC ADJUSTMENT DISPLAY 1" will appear and the parameter data for the Mode you have selected is shown in this dialog box.
7. The parameters will be filled with the data determined by the projector according to the present signal input.
8. The function of the parameters and their values are summarized in the table as bellow.
9. Move the arrow to an adjusting item you want to adjust by pressing the POINT UP/DOWN BUTTON(s).
10. To increase the level, point the arrow to  $\triangle$  and then press the SELECT (REAR CLICK) BUTTON. To decrease the level, point the arrow to  $\nabla$  and then press the SELECT (REAR CLICK) BUTTON.
11. If you want to store the settings to the memory, move the arrow to Stored and press the SELECT (REAR CLICK) BUTTON. When you have stored the settings, you will see "OK ?" as a confirmation. Move the arrow to Yes and then press the SELECT (REAR CLICK) BUTTON .
12. To recall the parameter data before setting, move the arrow to Reset and then press the SELECT (REAR CLICK) BUTTON. When you have reset the settings, you will see "OK ?" as a confirmation. Move the arrow to Yes and then press the SELECT (REAR CLICK) BUTTON . You can adjust the settings again if required.
13. To quit the MENU, move the arrow to Quit and then press the SELECT (REAR CLICK) BUTTON.
14. If you quit the MENU without storing the settings to the memory, the parameter data you changed will not be kept.
15. The stored settings are permanently kept even if the MAIN ON/OFF is switched off.
16. When the adjustment of "Clamp", "Height" and "Width" are required, move the arrow by pressing the POINT UP/DOWN BUTTON(s) to select ( $\blacktriangledown$ ). Press the SELECT (REAR CLICK) BUTTON.

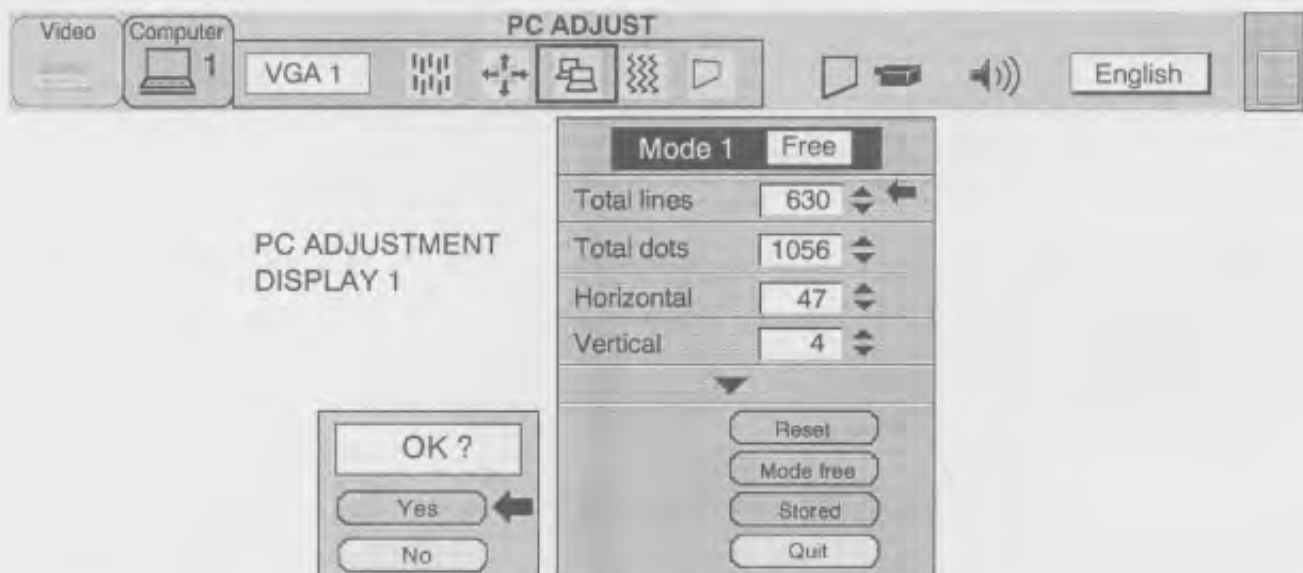

ITEM	FUNCTION
<b>TOTAL LINES</b>	The number of the total vertical lines. Adjust the number to match your PC image.
<b>TOTAL DOTS</b>	The number of the total dots in one horizontal period. Adjust the number to match your PC image.
<b>HORIZONTAL</b>	Adjustment of the horizontal picture position. When the image is not centered on the screen, adjust this.
<b>VERTICAL</b>	Adjustment of the vertical picture position. When the image is not centered on the screen, adjust this.

17. Another dialog box "PC ADJUSTMENT DISPLAY 2" will appear and the parameter data for the Mode you have selected is shown in this dialog box.
18. Move the arrow to an adjusting item you want to adjust by pressing the POINT UP/DOWN BUTTON(s).
19. To increase the level, point the arrow to  $\triangle$  and then press the SELECT (REAR CLICK) BUTTON. To decrease the level, point the arrow to  $\nabla$  and then press the SELECT (REAR CLICK) BUTTON.
20. If you want to store the settings to the memory, move the arrow to Stored and press the SELECT (REAR CLICK) BUTTON. When you have stored the settings, you will see "OK ?" as a confirmation. Move the arrow to Yes and then press the SELECT (REAR CLICK) BUTTON .
21. To recall the parameter data before settings, move the arrow to Reset and then press the SELECT (REAR CLICK) BUTTON. When you have reset the settings, you will see "OK ?" as a confirmation. Move the arrow to Yes and then press the SELECT (REAR CLICK) BUTTON . You can adjust the settings again if needed.
22. To quit the MENU, move the arrow to Quit and then press the SELECT (REAR CLICK) BUTTON.
23. If you quit the MENU without storing the settings to the memory, the parameter data you changed will not be kept.
24. The stored settings are permanently kept even if the MAIN ON/OFF is switched off.

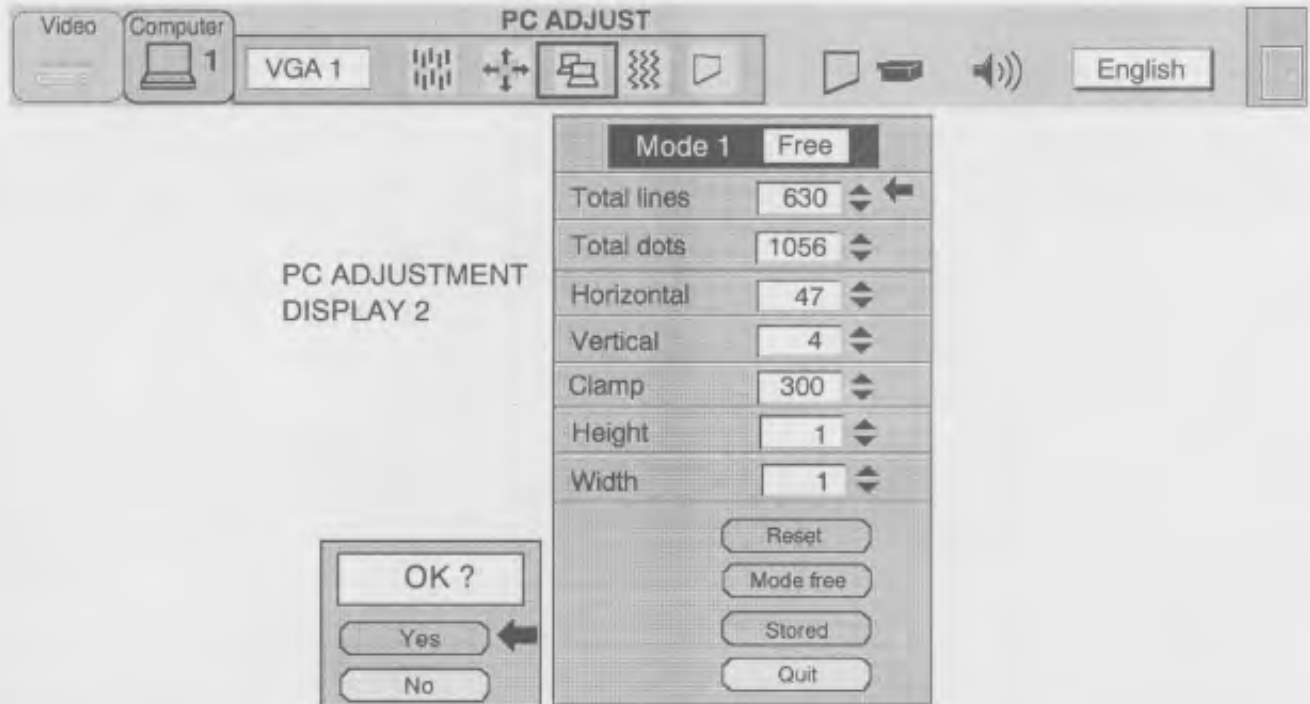

ITEM	FUNCTION
CLAMP	Adjustment of the clamp level. When the image has a dark bar, try this adjustment.
HEIGHT	Expanding or compressing level for the vertical direction.
WIDTH	Expanding or compressing level for the horizontal direction.



## MODE FREE

The Mode free function is designed to delete the parameter data produced by PC ADJUST.

1. Press the MENU BUTTON and the MAIN MENU DISPLAY dialog box will appear.
2. Press the POINT LEFT/RIGHT BUTTON(s) to select PC ADJUST and press the SELECT (REAR CLICK) BUTTON. Another dialog box "Where to reserve" will appear.
3. Press the POINT DOWN BUTTON and a red arrow will appear.
4. Move the arrow to one of the "Modes" (Stored position) that you want to delete by pressing the POINT UP/DOWN BUTTON(s). Press the SELECT (REAR CLICK) BUTTON. Another dialog box "PC ADJUSTMENT DISPLAY" will appear.
5. If you delete the parameter data, move the arrow by pressing the POINT UP/DOWN BUTTON(s) to select Mode free. Press the SELECT (REAR CLICK) BUTTON. You will see "OK?" as a confirmation.
6. Move the arrow to Yes and then press the SELECT (REAR CLICK) BUTTON to delete the parameter data.
7. To quit the MENU, move the arrow to Quit and then press the SELECT (REAR CLICK) BUTTON.

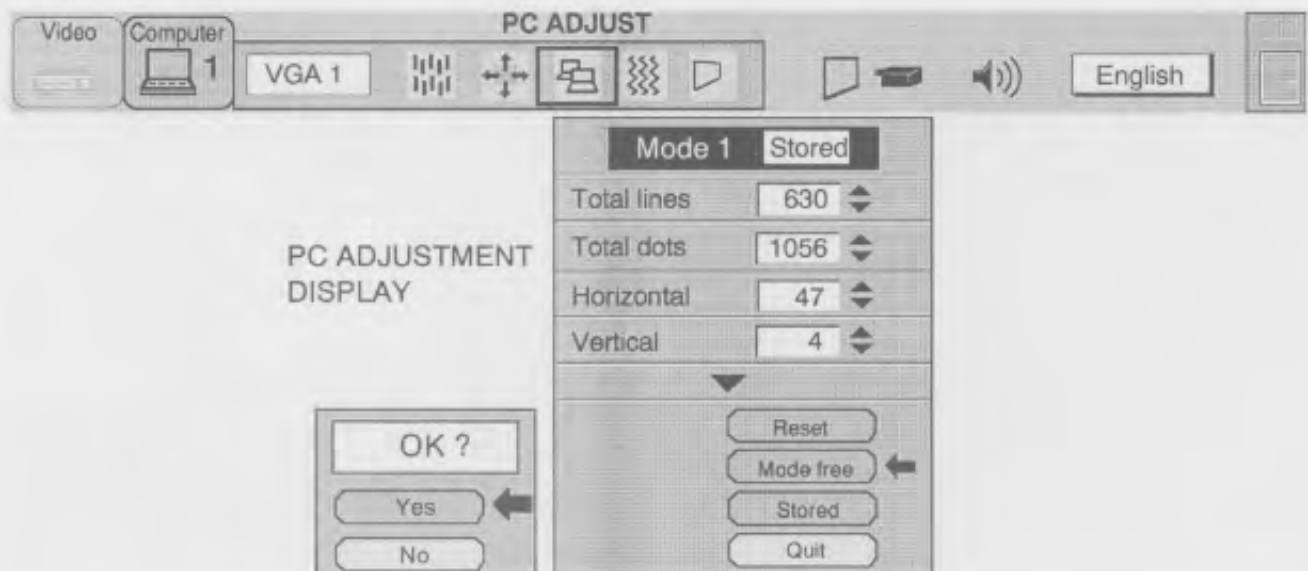
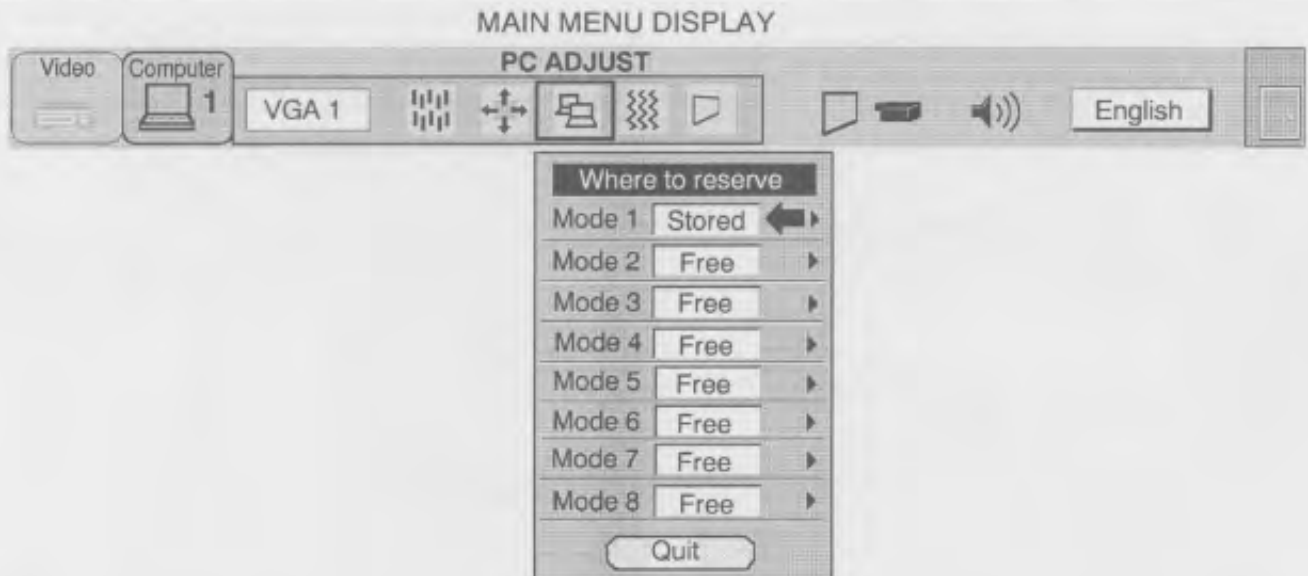

## AUTO IMAGE FUNCTION (COMPUTER MODE)

The Auto image function can automatically adjust the Fine sync., Total dots and Screen position for most computers.



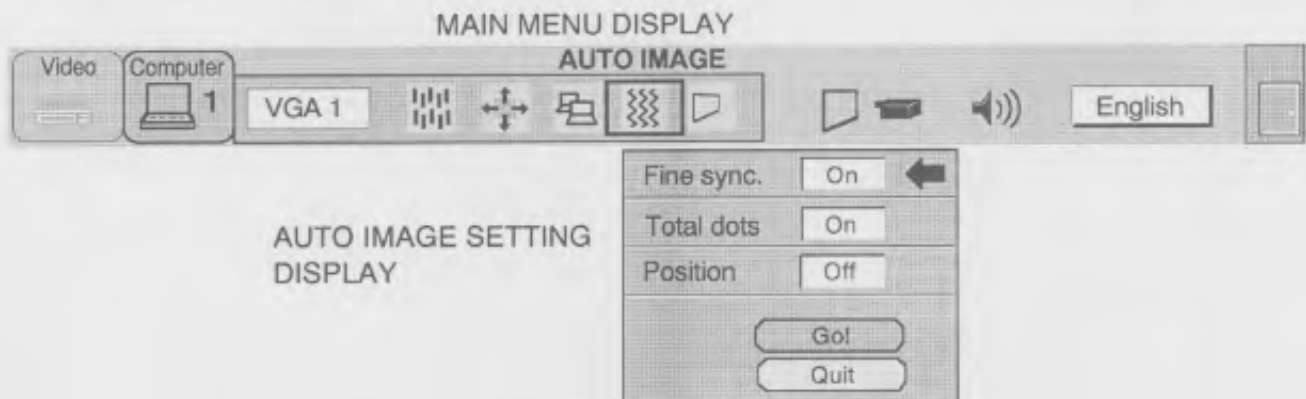

1. Press the MENU BUTTON and the MAIN MENU DISPLAY dialog box will appear.
2. Press the POINT LEFT/RIGHT BUTTON(s) to select AUTO IMAGE and press the SELECT (REAR CLICK) BUTTON. Another dialog box AUTO IMAGE SETTING DISPLAY will appear.
3. Press the POINT DOWN BUTTON and a red arrow will appear.
4. Move the arrow to an adjustment item(s) you want to adjust by pressing the POINT UP/DOWN BUTTON(s).
5. Change the setting "On" , press the SELECT (REAR CLICK) BUTTON.
6. Move the arrow by pressing the POINT UP/DOWN BUTTON(s) to select Go! and then press the SELECT (REAR CLICK) BUTTON. The auto image function is started now. It will take at 10 ~ 60 seconds.
7. To quit the MENU, point to Quit and then press the SELECT (REAR CLICK) BUTTON.
8. This setting is temporarily effective until you turn off the projector or changed the input signal.

NOTE: Depending upon the connected Personal Computer, the fine sync., total dots and screen position may not be fully adjusted with the "Auto Image Function". In that case, use the "Picture Image" and/or "Picture Position" adjustments (see pages 36 ~ 37) to make fine-adjust them after the "Auto Image Function" is executed.



## PICTURE SCREEN ADJUSTMENT (COMPUTER MODE)

This projector has a picture screen resizing function, which enables you to project the image different sizes.

Input image resolution	True Mode	Expand Mode	Compressed Mode	Panning Mode
Less than XGA (1024 × 768) image			None	None
XGA (1024 × 768) image		None	None	None
More than XGA (1024 × 768) image	None	None		

1. Press the MENU BUTTON and the MAIN MENU DISPLAY dialog box will appear.
2. Press the POINT LEFT/RIGHT BUTTON(s) to select SCREEN and press the SELECT (REAR CLICK) BUTTON. Another dialog box SCREEN ADJUST DISPLAY will appear.
3. Press the POINT DOWN BUTTON and a red arrow will appear.
4. To switch to "Expand mode", move the arrow to Expand by pressing the POINT UP/DOWN BUTTON(s) and then press the SELECT (REAR CLICK) BUTTON. The mode is changed to "Expand".
5. To switch to "True mode", move the arrow to True by pressing the POINT UP/DOWN BUTTON(s) and then press the SELECT (REAR CLICK) BUTTON. The mode is changed to "True".
6. To switch to "Compressed mode", move the arrow to Compressed by pressing the POINT UP/DOWN BUTTON(s) and then press the SELECT (REAR CLICK) BUTTON. The mode is changed to "Compressed".
7. To switch to "Panning mode", move the arrow to Panning by pressing the POINT UP/DOWN BUTTON(s) and then press the SELECT (REAR CLICK) BUTTON to change to "Panning".

Press the POINT UP/DOWN/LEFT/RIGHT BUTTON(s) to move the panning image position. The display of "Quit" is appearing on the screen during panning mode. If this display is disappeared, the panning mode is cancelled.

8. Press the SELECT (REAR CLICK) BUTTON to disappear the "Quit" display and panning mode is cancelled.
9. This setting is temporarily effective until you turn off the MAIN ON/OFF switch.

NOTE: The normal "Panning Operation" may not function properly if the computer system prepared with the "PC Adjust" is used.

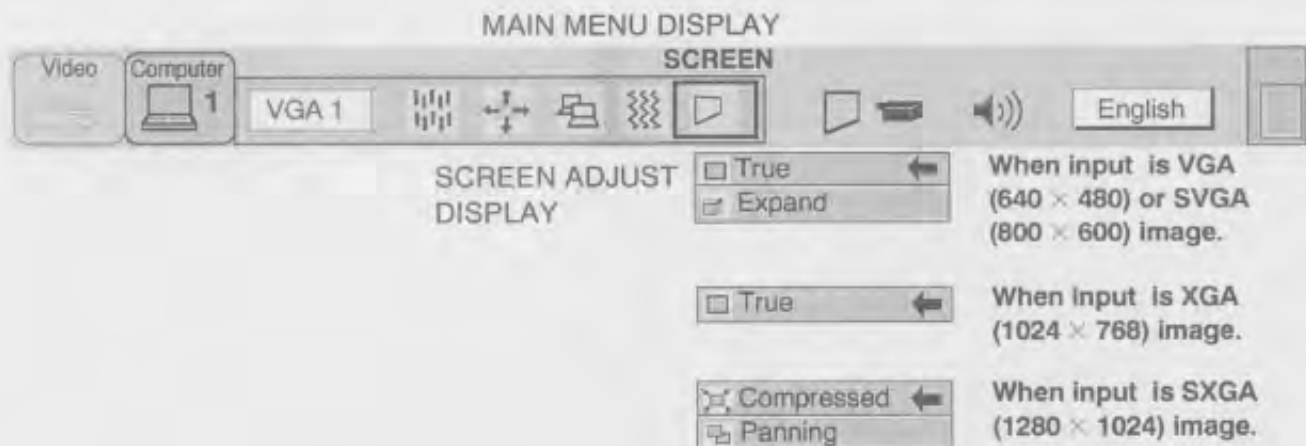

## **OTHER FUNCTION SETTING**

This projector has other function settings; Auto retract, Blue back, Display, Ceiling, Rear and Lamp age.

### **AUTO RETRACT**

When this function is in the "On" position, the lens is retracted into lens holder and shut the lens shutter door when the projector is turned off. To protect the lens from the damage while you are carrying the projector, you are strongly recommended to set this function "On". Since the lens is retracted in each time the POWER is switched off, you need to make ZOOM and FOCUS adjustments when you turn on the projector.

### **BLUE BACK**

When this function is in the "On" position, the projector will project a blue image without video noise on the screen when the video source is unplugged or turned off.

### **DISPLAY**

When this function is in the "On" position, on-screen displays always appear when adjustments are made. Although these on-screen displays are very helpful, these may spoil the view if adjustments are made during presentations. The certain displays do not appear when display switch is "Off". The following displays do not appear.

- Count-down Display
- Sound volume Display
- Sound mute Display
- Normal Display

### **CEILING**

When this function is in the "On" position, the top/bottom and the left/right picture reverse for a ceiling-mounted projector.

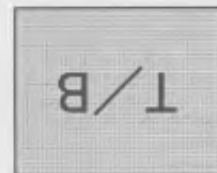

### **REAR**

When this function is in the "On" position, the left/right picture reverse for a rear projection.



### **LAMP AGE**

The Lamp age function is designed to reset the lamp replacement monitor timer. When replace the lamp, reset the lamp replacement monitor timer for used this function.

## AUTO RETRACT, BLUE BACK, DISPLAY, CEILING AND REAR

1. Press the MENU BUTTON and the MAIN MENU DISPLAY dialog box will appear.
2. Press the POINT LEFT/RIGHT BUTTON(s) to select SETTING and press the SELECT (REAR CLICK) BUTTON. Another dialog box SETTING DISPLAY will appear.
3. Press the POINT DOWN BUTTON and a red arrow will appear.
4. Move the arrow to a setting item you want to set by pressing the POINT UP/DOWN BUTTON(s).
5. If you want to change the setting (On or Off), press the SELECT (REAR CLICK) BUTTON.
6. To quit the MENU, point to Quit and then press the SELECT (REAR CLICK) BUTTON.
7. The settings are permanently kept even if the MAIN ON/OFF is switched off.

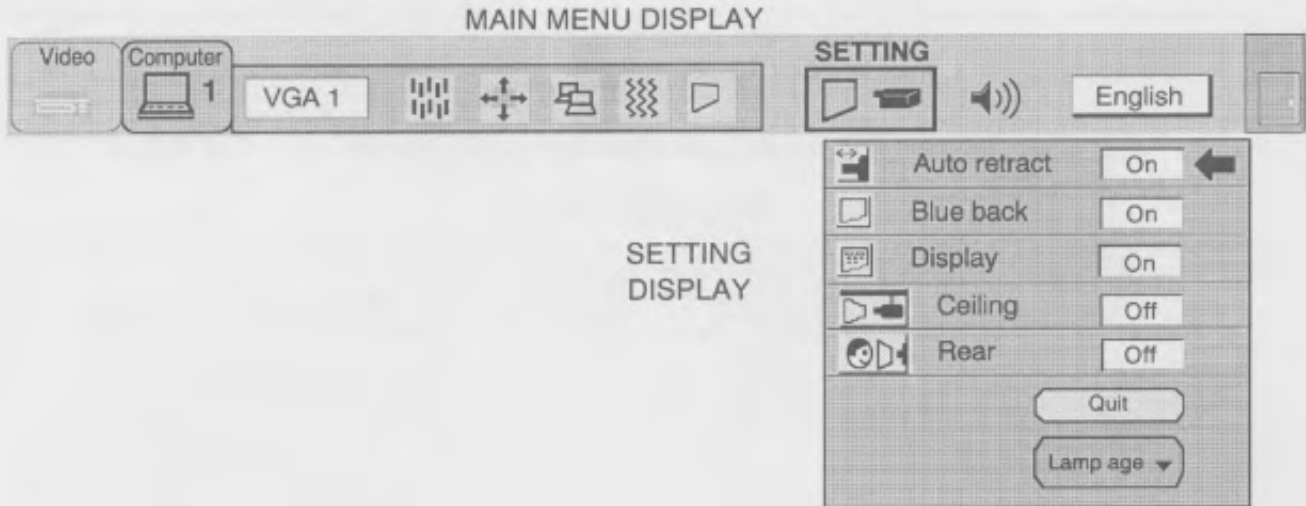

## LAMP AGE

**NOTE: The LAMP REPLACE MONITOR must be reset only after the lamp replacement.**

1. Press the MENU BUTTON and the MAIN MENU DISPLAY dialog box will appear.
2. Press the POINT LEFT/RIGHT BUTTON(s) to select SETTING and press the SELECT (REAR CLICK) BUTTON. Another dialog box SETTING DISPLAY will appear.
3. Press the POINT DOWN BUTTON and a red arrow will appear.
4. Move the arrow by pressing the POINT UP/DOWN BUTTON(s) to select Lamp age and then press the SELECT (REAR CLICK) BUTTON. When you reset the lamp replace monitor, you will see "lamp replace monitor reset?" as a confirmation.
5. Move the arrow to Yes and then press the SELECT (REAR CLICK) BUTTON, you will see "OK?" as a confirmation. Move the arrow to Yes and then press the SELECT (REAR CLICK) BUTTON, the lamp replace monitor is reset.
6. Move the arrow to No and then press the SELECT (REAR CLICK) BUTTON. The lamp replace monitor is not reset.
7. To quit the MENU, move the arrow to Quit and then press the SELECT (REAR CLICK) BUTTON.

### MAIN MENU DISPLAY



### SETTING DISPLAY

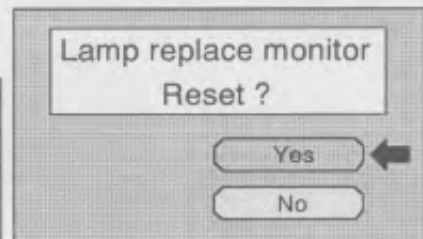
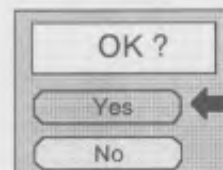
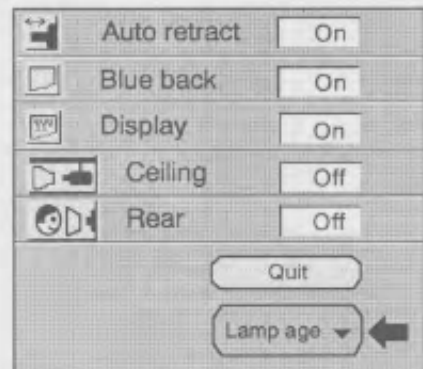

## AIR FILTER CARE AND CLEANING

The removable air filter prevents dust from accumulating on the surface of the projection lens and projection mirror. Should the air filter become clogged with dust particles, it will reduce the cooling fan's effectiveness and may result in internal heat build up and reduce the life of the projector.

To clean the air filter, follow the cleaning procedures below:

1. Turn the POWER (LAMP) ON/OFF button OFF.
2. Remove the air filter cover.  
Carefully place a coin against the indented part of the filter cover and lift.
3. Remove the air filter from the filter cover.
4. Clean the air filter with a vacuum cleaner.
5. Replace the air filter. Make sure that air filter cover is securely inserted.



Do not clean with water. Doing so may damage the air filter.  
Do not operate the projector with air filter removed.

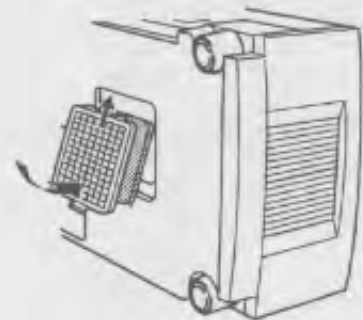
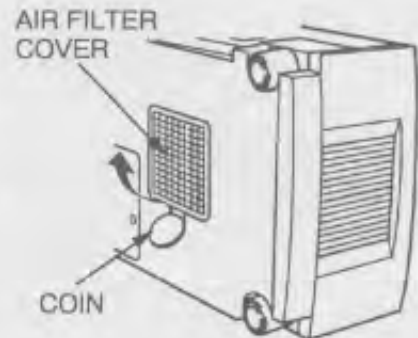

## RECOMMENDATION

**TO ENJOY PICTURE IMAGE, USE THE PROJECTOR IN THE CLEAN ENVIRONMENT. USAGE IN THE CLEAN ENVIRONMENT IS RECOMMENDED.**

When used under the dusty or smoky conditions, dust may accumulate on the liquid crystal panel and lens inside it, and may resultantly be projected on the screen together with the picture.

When the above symptoms are noticed contact the place where your authorized dealer or service station for the cleaning.

## TEMPERATURE WARNING INDICATOR

The TEMPERATURE WARNING INDICATOR flashes red when the internal temperature of the projector exceeds the normal temperature.

Possible causes for the temperature warning may be:

1. Ventilation slots of the projector are blocked. In such an event, reposition the projector so that ventilation slots are not obstructed.
2. Air filter is clogged with dust particles. Remove dust from the air filter by following instructions in the Air Filter Care and Cleaning section above.

If the TEMPERATURE WARNING INDICATOR still continues to flash after checking (1) and (2), call your authorized dealer or service station.

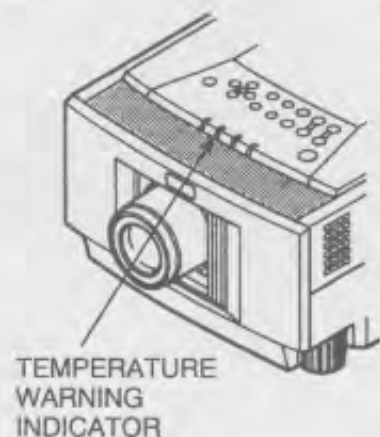

# LAMP REPLACEMENT

If the lamp fails to come on and the lamp monitor on the projector light is orange, you must replace the lamp.



- For continued safety, replace with a lamp assembly of the same type.
- Allow the projector to cool for at least 45 minutes before you open the lamp cover. The inside of the projector can become very hot.
- Do not drop the lamp module or touch the glass part ! The glass can shatter and cause injury.

Follow these steps to replace the lamp assembly.

1. Turn off the projector and allow the projector to cool thoroughly.
2. Disconnect the AC cord from the projector.
3. Remove screw with a screwdriver and disconnect the lamp cover.
4. Remove 2 screw with a screwdriver and pull out the lamp assembly by grasping the handle.
5. Replace the lamp assembly.
6. Tighten 3 screws to secure the lamp assembly and lamp cover.
7. Connect the detachable AC cord to the projector.

LAMP REPLACEMENT INDICATOR

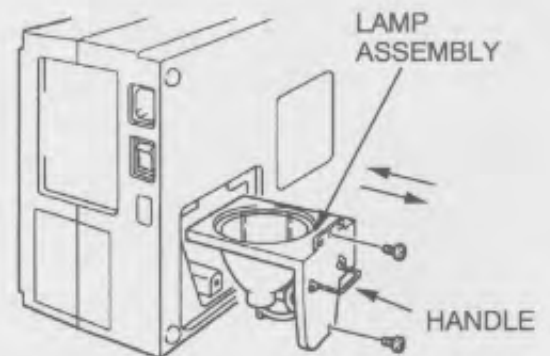
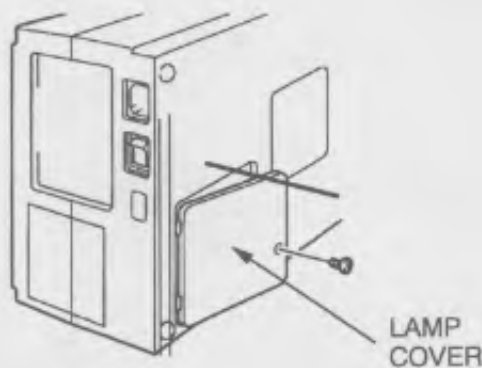
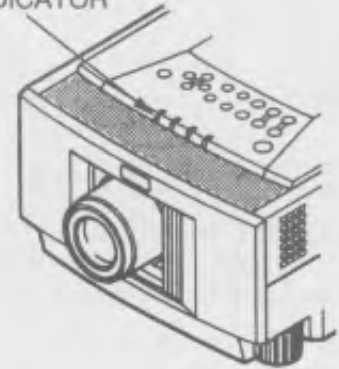

8. After replacing the lamp, you must reset the LAMP REPLACEMENT MONITOR TIMER. (See "LAMP AGE" section on page 46.)

**NOTE:** Do not reset the LAMP REPLACEMENT MONITOR TIMER, except after the lamp replacement.



## CLEANING THE LENS

Follow these steps to clean the projection lens:

1. Use a non-abrasive camera lens cleaner with a soft, dry cleaning cloth.  
 Avoid using an excessive amount of cleaner.  
 Abrasive cleaners, solvents or other harsh chemicals might make scratch on the lens.
2. Lightly wipe the cleaning cloth over the lens.

## TROUBLESHOOTING

Problem:	Try these Solutions:
<b>No power</b>	<ul style="list-style-type: none"> <li>● Plug the projector into an AC outlet.</li> <li>● Turn the MAINS ON/OFF button to ON.</li> <li>● Be sure the READY INDICATOR light is ON.</li> </ul> <p><b>NOTE:</b> After pressing the LAMP POWER ON/OFF button to OFF . The projector functions as follows.</p> <ol style="list-style-type: none"> <li>1. The LAMP POWER indicator will light and the READY indicator will turn off.</li> <li>2. After one minute, the READY indicator will light green again and the projector can be turned on by pressing the LAMP POWER ON/OFF button.</li> </ol> <ul style="list-style-type: none"> <li>● Check temperature warning indicator. If the indicator flashes red, the projector cannot be turned on.            (See "USING THE PROJECTOR" section on page 27).</li> <li>● Check the projection lamp.</li> </ul>
<b>No Image</b>	<ul style="list-style-type: none"> <li>● Check if computer or video cables are connected to the Projector and the computer or video equipment.</li> <li>● Check the color system. (Video Mode).</li> <li>● Check the computer system. (Computer Mode).</li> </ul>
<b>Image is out of focus</b>	<ul style="list-style-type: none"> <li>● Adjust the focus.</li> <li>● Make sure the projection screen is at least 3.6 feet (1.1 m) from the projector.</li> <li>● Check if the projection lens is dark.</li> </ul> <p><b>NOTE:</b> Moving the projector from a cool temperature location to a warm temperature location may result in moisture condensation on the lens. In such an event, leave the projector OFF and wait until condensation disappears.</p>

Problem:	Try these Solutions:
<b>Picture is L/R Reversed.</b>	Check Ceiling/Rear feature. (See "OTHER FUNCTION SETTING" section on pages 44 ~ 45).
<b>Picture is T/B Inverted.</b>	Check Ceiling feature. (See "OTHER FUNCTION SETTING" section on pages 44 ~ 45).
<b>Some displays are not seen during the operation.</b>	Check DISPLAY feature. (See "OTHER FUNCTION SETTING" section on pages 44 ~ 45).
<b>No sound.</b>	<ul style="list-style-type: none"> <li>● Check audio cable connection from audio input source.</li> <li>● Check the audio source.</li> <li>● Press the VOLUME (+) button.</li> <li>● Press the MUTE button.</li> </ul>
<b>Remote control unit doesn't work.</b>	<ul style="list-style-type: none"> <li>● Check the batteries.</li> <li>● Make sure nothing is blocking between the remote control sensor and remote control unit.</li> <li>● Make sure you are not too far from the projector when using the remote control unit. {Maximum operate range 16.4 feet (5 m)}.</li> </ul>
<b>Wireless mouse function does not work.</b>	<ul style="list-style-type: none"> <li>● Check the cable connection between the projector and the computer.</li> <li>● Check the mouse setting on your computer.</li> <li>● Turn on the projector before you turn on the computer.</li> </ul>

# TECHNICAL SPECIFICATIONS

## SPECIFICATIONS

<b>Projector Type</b>	Multi-media Projector
<b>Dimensions (W x H x D)</b>	10.2" (260 mm) × 6.3" (159 mm) × 16.0" (404 mm)
<b>Net Weight</b>	14.3 lbs (6.5 kg)
<b>LCD Panel System</b>	1.3" TFT Active Matrix type (Thin Film Transistor) × 3
<b>Number of Pixels</b>	2,359,296 {786,432 (1,024 × 768) × 3}
<b>Color System</b>	4 color system (NTSC, PAL, SECAM and NTSC4.43)
<b>Scanning Frequency</b>	H-sync. 15 ~ 80 KHz, V-sync. 50 ~ 100 Hz
<b>Projection Image Size (Diagonal)</b>	Adjustable from 20" to 400"
<b>Contrast</b>	100 :1 (ANSI)
<b>Horizontal Resolution</b>	800 TV lines
<b>Projection Lens</b>	F2.5 ~ 3.2, f1.77" ~ 2.95" with Motor zoom and focus
<b>Throw Distance</b>	3.6' (1.1 m) ~ 47' (14.3 m)
<b>Projection Lamp</b>	120 watt UHP type
<b>Projection Mirror</b>	Dichroic mirror and X-prism system
<b>AV Input Jacks</b>	RCA Type × 3 (Video, Audio R and L) and DIN 4 pin (S-Video) × 1
<b>Computer Input Jack</b>	(VGA) HDB15 Terminal × 2, Multi-pole 12 pin (Control port) × 2
<b>Monitor Output Jack</b>	(VGA) HDB15 Terminal × 1
<b>Computer Audio Input Jack</b>	Mini Stereo Type × 2
<b>Video Monitor Output Jack</b>	RCA Type × 1
<b>Audio Monitor Output Jacks</b>	RCA Type × 2 (R and L)
<b>Other Jacks</b>	EXT. Speaker Jack × 1
<b>Built-in Speaker</b>	(2) 4 cm × 7 cm, Stereo (R and L), 3 watt + 3 watt (Music Power)
<b>Image Elevation Adjustment</b>	Up to 6.5°
<b>Voltage</b>	100 ~ 120V AC, 50/60 Hz
<b>Power Consumption</b>	2.0A (Max. Ampere)
<b>Operating Temperature</b>	5°C ~ 35°C
<b>Storage Temperature</b>	- 10°C ~ 60°C
<b>Remote Control Battery</b>	(2) AA Type



This symbol on the nameplate means the product is Listed by Underwriters Laboratories Inc. It is designed and manufactured to meet rigid U.L. safety standards against risk of fire, casualty and electrical hazards.

# EIKI

**Audio Visual/Video Products**

**EIKI INTERNATIONAL, INC.**

26794 Vista Terrace Drive, Lake Forest, CA. 92630-8113

TEL (714) 457-0200 FAX (714) 457-7878

**IN CANADA, EIKI CANADA**

865 Heritage Drive P.O. Box 156

Midland Ontario L4R 4K8 Canada

TEL (705) 527-4084 FAX (705) 527-4087